



Spectrum Series

Electric Wall/Ceiling Projection Screen

User's Guide (Z - Type)

Important Safety & Warning Precautions

Make sure to read this user's guide and follow the procedures below.

Caution: The screen's Black Top Drop is already set to its maximum drop distance. There is NO extra Black Top Drop in the roller. Please be aware of this, as it will void your warranty with Elite Screens. Unapproved changes or modifications (except for cutting the power cord for hardwire installations) to this unit are prohibited and will void your warranty.

- Please retain this user's guide for future reference.
- To avoid damaging the unit, do not use with any unauthorized accessories not recommended by the supplier.
- Handle the unit carefully during transportation to avoid any damages.
- To ensure safe and reliable operation, direct connection to a properly grounded power source is advised.
- The power outlet supplying power to the unit should be close to the unit and easily accessible.
- Do not install the unit on uneven or inclined surfaces.
- Do not put heavy objects on the power cord and position it properly to avoid creating a trip obstacle.
- Never overload the power cord to prevent an electric shock or fire due to a loose contact or a short circuit.
- There are not user serviceable parts in this unit. Do not attempt to disassemble this unit by yourself. No one except authorized technicians can open and make repairs to this unit.
- Make sure the power source this unit is connected to has a continuous power flow.
- If there is need to use an extension cord, make sure the cord has an equal rating as the appliance to avoid overheating.
- Do not handle the power plug when your hands are wet or your feet are in contact with water.

Do not use this unit under the following circumstances.

- Disconnect the power cord under the conditions of heavy rain, wind, thunder or lightning.
- Avoid direct Sunshine, rain shower and moisture.
- Keep away from fire sources and high temperature to prevent this device from overheating.
- Cut off the power supply first before transportation or maintenance.
- Fully disconnect from the power supply when the unit is not in use for a long period of time, as should be done with any other electric household appliance.
- To avoid possible injury and/or an electric shock, do not attempt to use the screen if there is obvious damage or if there are any evident broken parts.

NOTE:

This equipment has been tested and found to comply with the limits for a Class B digital device, pursuant to Part 15 of the FCC Rules.

These limits are designed to provide reasonable protection against harmful interference in a residential installation. This equipment generates and can radiate radio frequency energy and, if not installed and used in accordance with the instructions, may cause harmful interference to radio communications.

However, there is no guarantee that the interference will not occur on a particular installation. If this equipment causes harmful interference to radio or television reception, which can be determined by turning the equipment off and on, the user is encouraged to try to correct the interference by one or more of the following measures.

- ✓ **Reorient or relocate the receiving antenna of the device, which may be causing the interference.**
- ✓ **Increase the separation between the screen and the device's receiver.**
- ✓ **Connect the equipment into a different power outlet other than the device.**

Pre-Installation

1. Carefully unpack the screen.
2. Always handle the screen in a leveled position on a clean surface.
3. In order to protect the screen from exposure to stains, keep the screen out of contact with foreign particles such as dust, sawdust, and/or liquids.

NOTE

Wall screws included with this product are complementary and may not be adequate for all mounting surfaces. Consult with a professional installer or hardware store for proper mounting screws and anchors.

Regardless of the mounting method, the screen should be securely supported so that the vibration or pulling on the viewing surface will not cause the casing to become loose or fall. Included mounting screws are complimentary and may not be appropriate for all mounting surfaces. Use appropriate anchors to safely secure the screen to the mounting surface or consult with a professional installer.

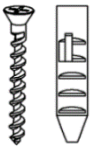
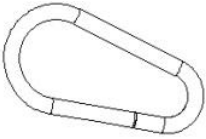
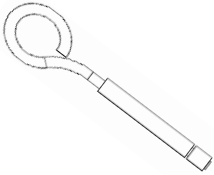
Hardware Parts List		
Please make sure all parts listed below are included before proceeding with the installation.		
A. Screw/Anchor x 2	B. Snap link x 2	C. M6.5 eyebolt screw x 2
		

Installation Instructions

For installation assistance, please consult a professional Installer. Elite Screens is not liable for faulty installations.

A. Wall Mount (flushed)

Step 1: Measure and mark the (A) distance between the two holes on each bracket.

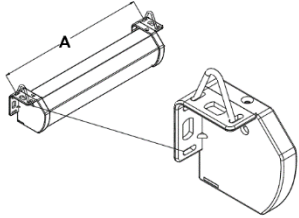

Step 2: Drill a hole for each screw hole on the marked areas. Insert a **dry-wall anchor** into the wall. Then screw the **M5x60 Screw** in each **dry-wall anchor** and leave about 1/8" of an inch.

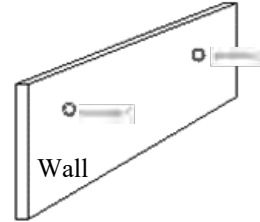

Step 3: Hang the screen by aligning the end cap holes to the **M5x60 screws**.

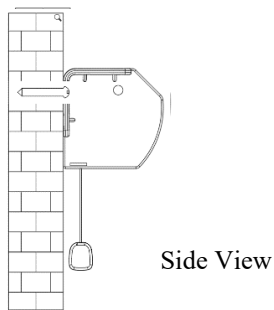

Step 4: Please make sure the screen is level.

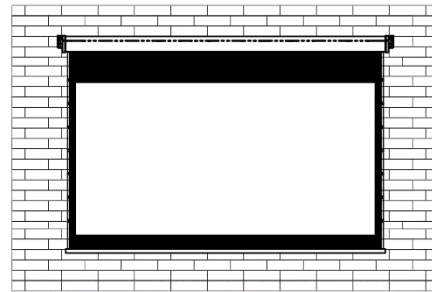

B. Ceiling Mount (suspended)

Step 1: Measure and mark the (A) distance between the two loops on each bracket.

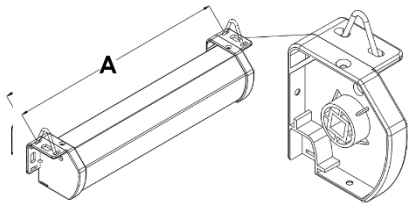

Step 2: Drill a hole on all marked areas and insert the **M6.5 eyebolt screw** into the hole, then secure it in place with a mallet/hammer.

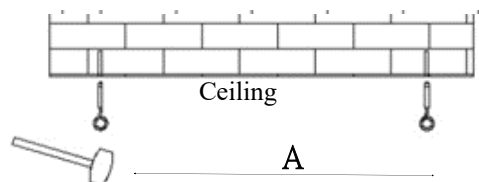

Step 3: Attach the snap link through the eyebolt and connect it to the loop on the screen's end cap. **For 150" models and above, connect snap link to end cap hole.**

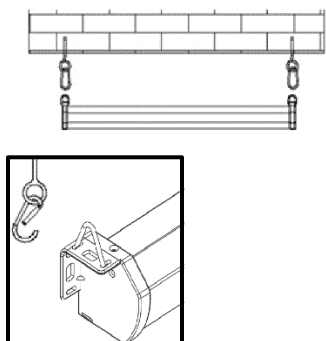

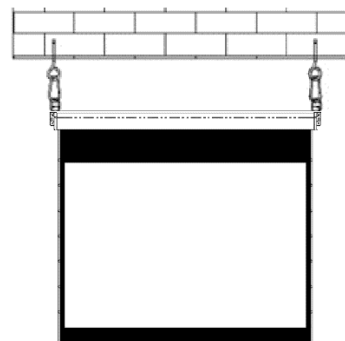

Step 4: Please make sure the screen is level.



Screen operation

Electric Current: Depending upon region, your Elite Screen will operate on 100V, 110V, or 220V voltage.

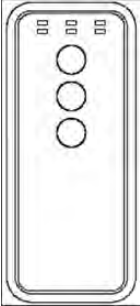
1. After ensuring the power outlet & screen are compatible (voltage), plug the power cord into the power outlet.
2. Once the screen has power, you'll be able to control it using any of the 3 ways described below:

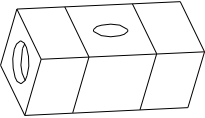
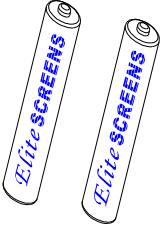
Control and Accessories List				
				
A. IR remote x 1	B. 3-way wall switch x 1	C. 12-volt trigger cable x 1	D. Bubble level x 1	E. AAA batteries x 2

1. 5-12V Trigger: The built-in 5-12V trigger input allows your screen to synchronize its drop & rise with the projector's power cycle. The screen deploys when the projector powers up and will retract when the projector powers down. The 5-12 volt adaptor connects to your projector's trigger output via a separate cable that may or may not be provided by the manufacturer of the projector. The trigger feature will not work without an output cable from the projector, but it can be tested by connecting the Red (+) and Green (-) cable to a 9-volt battery.

2. 3-Way Wall Switch: The 3-way wall switch is a wall mount control box with an up/stop/down button and plugs directly into the screen's RJ-45 input.

3. IR Remote Control: The Infrared functions by direct line of sight contact with a beam range of 30 feet.

For more information, technical support or your local Elite Screens contact, please visit www.elitescreens.com

SCREEN MATERIAL DISCLAIMER:

At first, the screen material may have a series of noticeable horizontal lines on its surface. These are known as memory lines. Memory lines are caused when the pliable projection material is rolled up and stored for the duration between its production and sale. This is both a normal and correctable phenomenon. For non-tensioned screens, you may also notice curling along the edges of the material. This is mainly due to environments in cold temperatures. Please try the following to alleviate the memory lines and side curls on the material. After installation, leave the screen in the down position for a few days in a warm room environment (above 75 degrees) and then commence regular (up/down) usage. This allows the material to stretch out and cure itself. After a few days, the lines should vanish and the edge curling will alleviate and will neither return nor affect the projected image during the years of its use.

SHORT THROW PROJECTION DISCLAIMER

Using a *short throw projector* on a *non-tensioned* type screen will result in image distortion as the slightest wave on the viewing surface will become more evident.

For *short throw projectors*, Elite Screens recommends the use of a **motorized tab-tensioned, fixed frame or whiteboard** projection screen.

Examples of undoctored projection images using a **standard throw** and **short-throw** projector

Standard throw projected image shown below (waves are not visible)

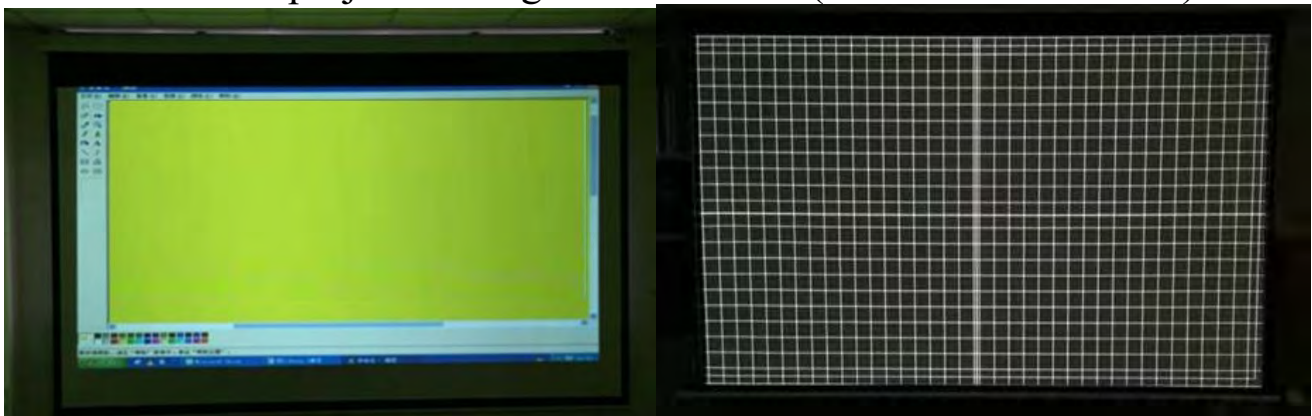

This ***short throw*** projected image shown below, demonstrates how waves on the surface become more pronounced:

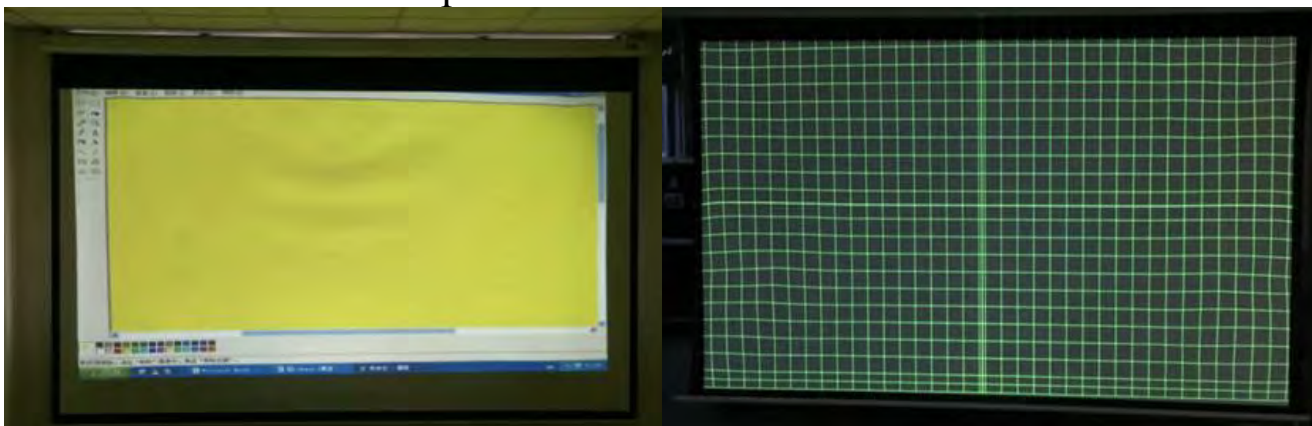

Actual Projection Images by two different Elite Screens model with ***Standard Throw Projector*** (Model #:ViewSonic Pro8300) vs. ***Short Throw Projector*** (Model #:BenQW710ST)

Direct Sunlight Disclaimer

Projection Screens from any maker are not designed for use as a window curtain and should never be exposed to direct sunlight. Prolonged exposure to solar radiation will destroy synthetic materials and such damage is not covered by our standard warranty.

See examples below.

