



Sable Frame B2 Series

Fixed Frame Screen

USER'S GUIDE

Thank you for choosing an Elite Screens fixed frame projection screen! *Congratulations on your new Sable Frame B2 purchase!* Please read through this user guide before utilizing the screen. Correct usage and maintenance will ensure a long product life.



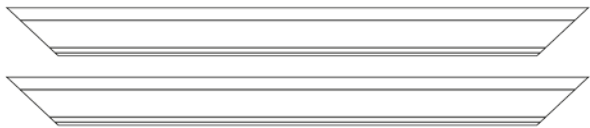
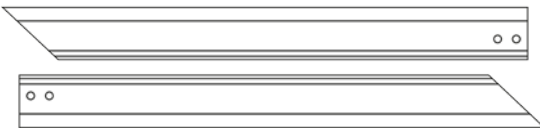
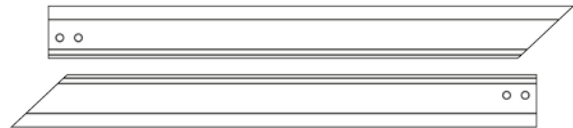

Care & Use Instructions

Dust, dirt and scratches on the projection surface will affect the picture quality, please take note of the points below to prevent that from occurring:

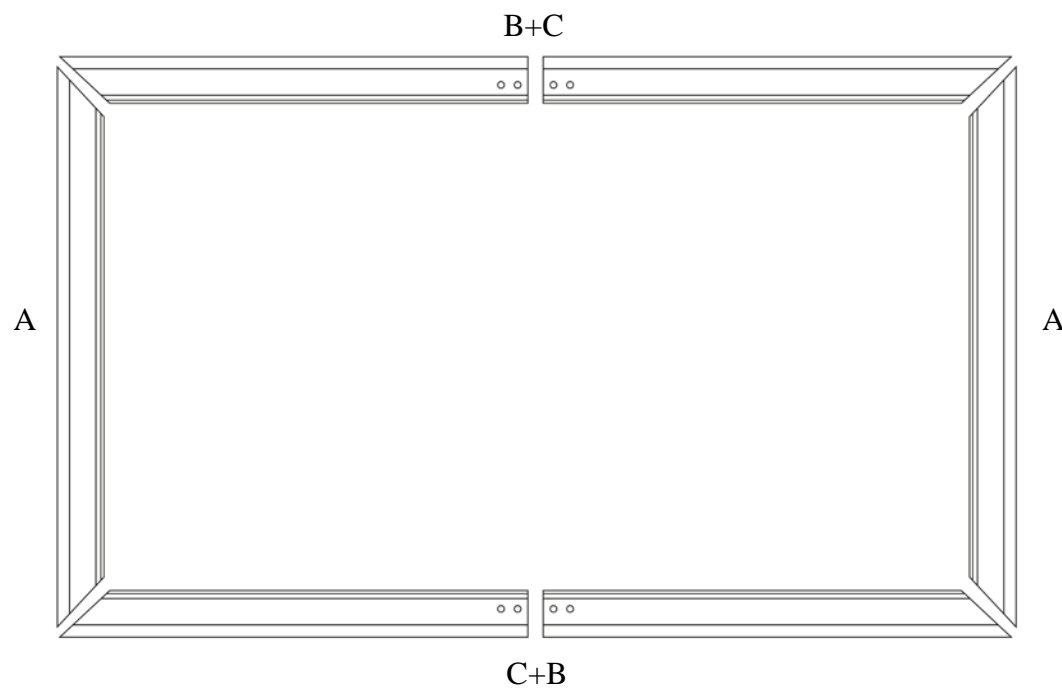
1. Do not touch the projection surface with your hands
2. Do not write or draw on the projection surface
3. Do not use fingers or sharp objects to point on the projection surface; this will damage the screen material.
4. Use a soft-damp cloth to clean the projection surface; do not use chemical cleaning agents or alcohol.
5. Use clean water when dampening the cleaning cloth and do not rub against the material to clean it.

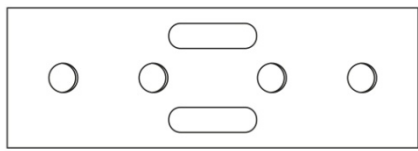
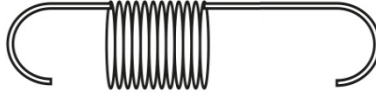
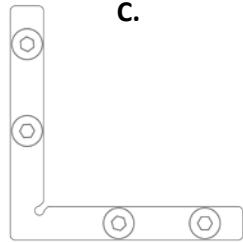
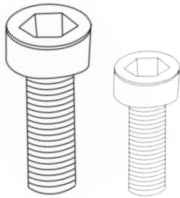
Frame Parts List		
A. Vertical Frame x 2pcs 	B. 1/2 Horizontal Frame x 4 pcs 	C. 1/2 Horizontal Frame x 2pcs 

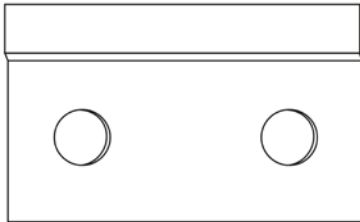

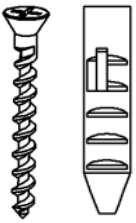
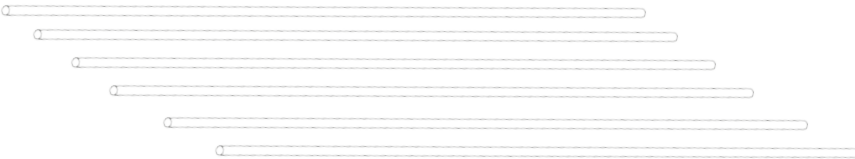
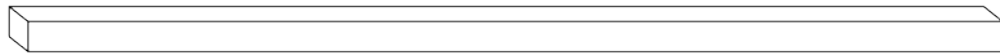
Hardware Parts List			
A. 	B. 	C. 	D. 
E. 	F. 	G. 	H. 
I. 		J. 	

Item	Parts List	92" Screen	100" Screen	110" Screen	120" Screen	135" Screen	150" Screen	180" Screen	200" Screen
A.	Center Joints	2	2	2	2	2	2	2	2
B.	Springs	36	38	42	44	50	54	66	72
C.	Elbow Joints	8	8	8	8	8	8	8	8
D.	Large Hex Screw/Small Hex Screw	4/32	4/32	4/32	4/32	4/32	4/32	4/32	4/32
E.	Pull Hook	1	1	1	1	1	1	1	1
F.	Wall Bracket	2	2	2	2	2	2	3	3
G.	Allen Key	2	2	2	2	2	2	2	2
H.	Wood Screws/Anchors	4/4	4/4	4/4	4/4	4/4	4/4	6/6	6/6
I.	Tension Rods	6	6	6	6	6	6	6	6
J.	Center Support Bar	1	1	1	1	1	1	1	1

Note: Additional spare parts may be included.

Assembly

Step 1. Place a soft-clean cloth on the ground or other flat surface of the area where the screen will be assembled.

Step 2. Position the pieces of the frame face-down on the soft-clean cloth in the arrangement shown below.

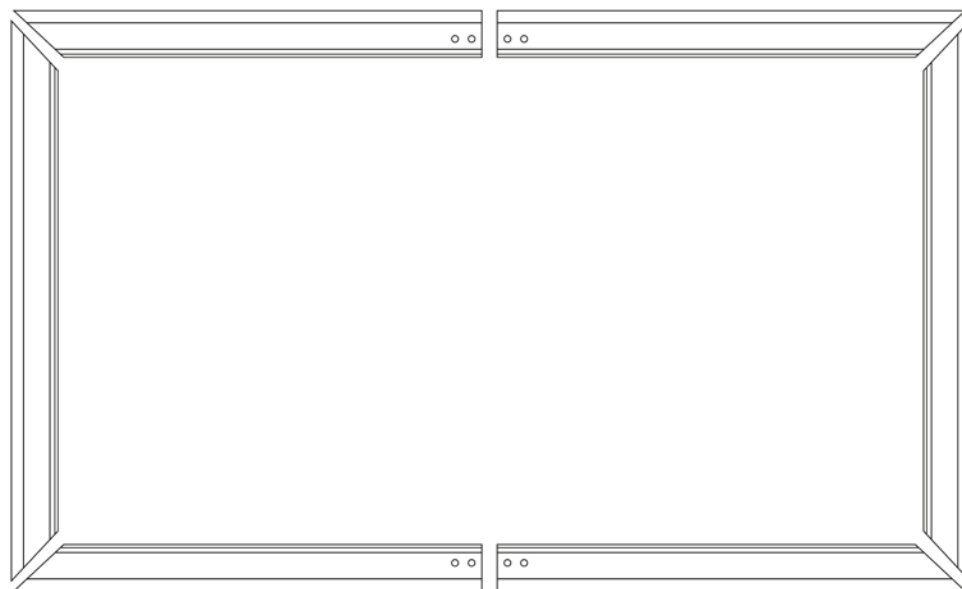

Step 3. Both Horizontal Frame parts should each have the *Center Joint (A)* already secured on one side with two *Large Hex Screws (D)*. Insert the *Center Joint (A)* connectors into the other half of the horizontal frame and fasten with two *Large Hex Screws (D)*.

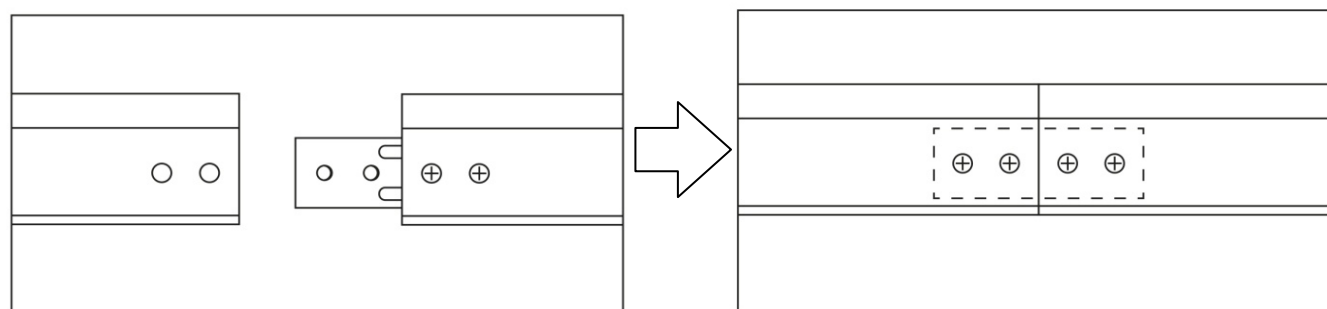

Step 4. Insert the *Elbow Joints (C)* to top and bottom sections of the vertical frame. Once inserted, secure the *Elbow Joints (C)* by fastening them with the *Small Hex Screws (D)* and connect the vertical sections to the horizontal frame sections. Make sure all corner frames pieces are flush (no gaps). They should form perfect right angles.

Do not tighten completely until all frame pieces are assembled correctly.

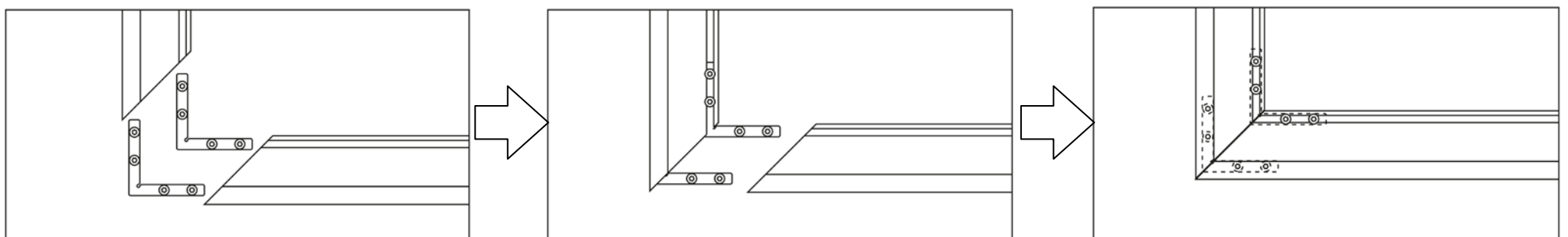

Note: You may have to loosen and adjust the brackets and frame pieces. It will help to leave the screws loose until perfect right angles are formed, then tighten the screws securely.

To prevent permanent damage to the screen material, be sure your hands are clean for the next step.

Step 5. Carefully unroll the screen material face-down on, top of the assembled frame, from one side of the frame to the other side as shown below.

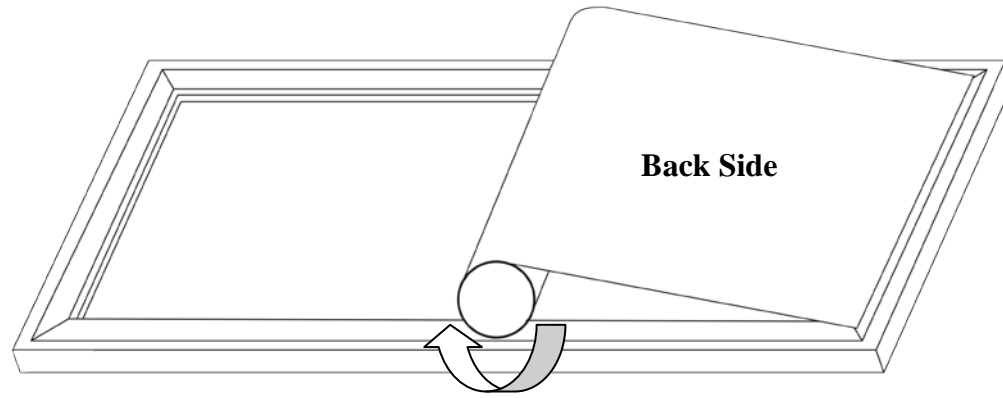

Step 6. Insert the four horizontal and two vertical *Tension Rods (I)* into the corresponding sides of the screen material, while keeping the material laying flat. Careful not to snag on the holes at the edge of the material during this process; forcing the rods may damage the screen material.

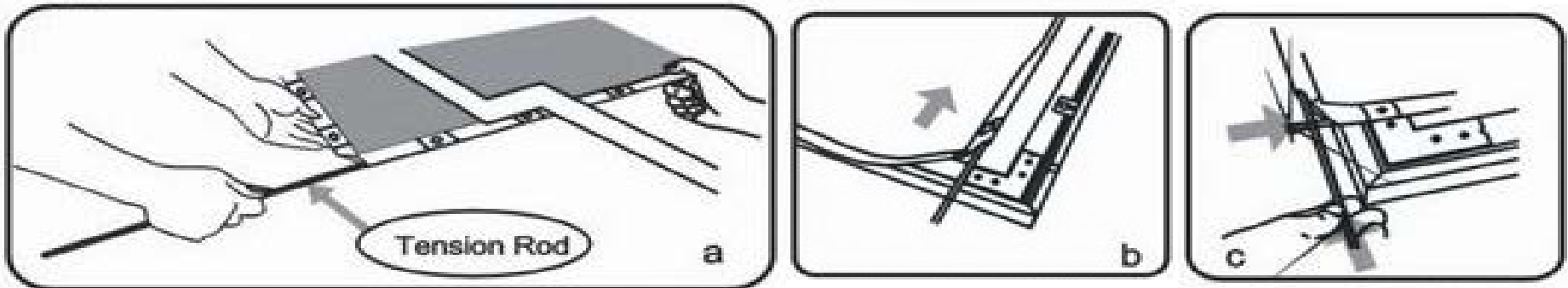

Step 7. Insert the *Springs (B)* into the grooves of the frame. Line them up with the corresponding holes in the materials edge. Be sure the shorter hook on each spring is placed in the frame's groove, while the longer hook attaches to the material. For the correct amount of springs to place into the frame, please refer to the table listed below.

Screen Size	Qty	
	Horizontal Spring	Vertical Spring
92"	22	14
100"	24	14
110"	26	16
120"	28	16
135"	32	18
150"	34	20
180"	42	24
200"	46	26

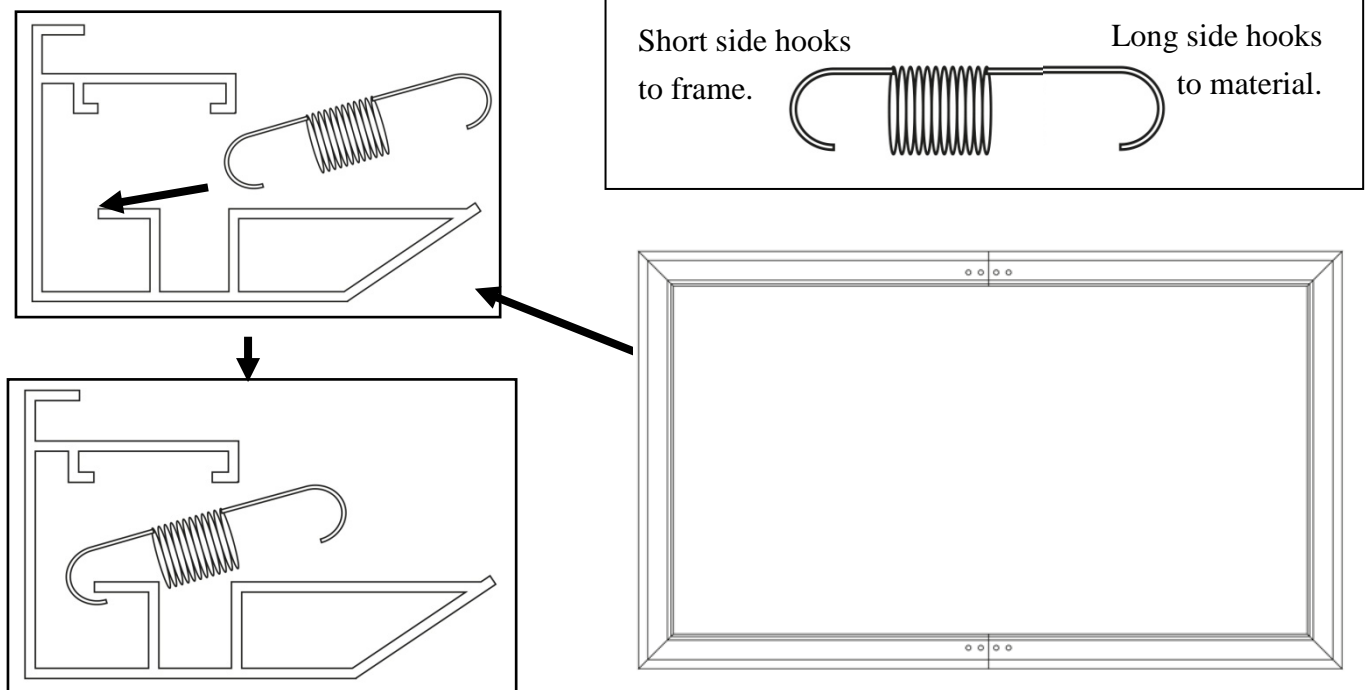

Step 8. With one end of the spring placed inside the groove of the frame, hook the *Spring (B)* through the hole located on the screen material's outer edge. **Be sure to hook the *Springs (B)* onto the *Tension Rod (I)* to avoid damage to the screen material.** Use the *Pull Hook (E)* when necessary. Attach the four corners and center horizontal sections of the material (1).

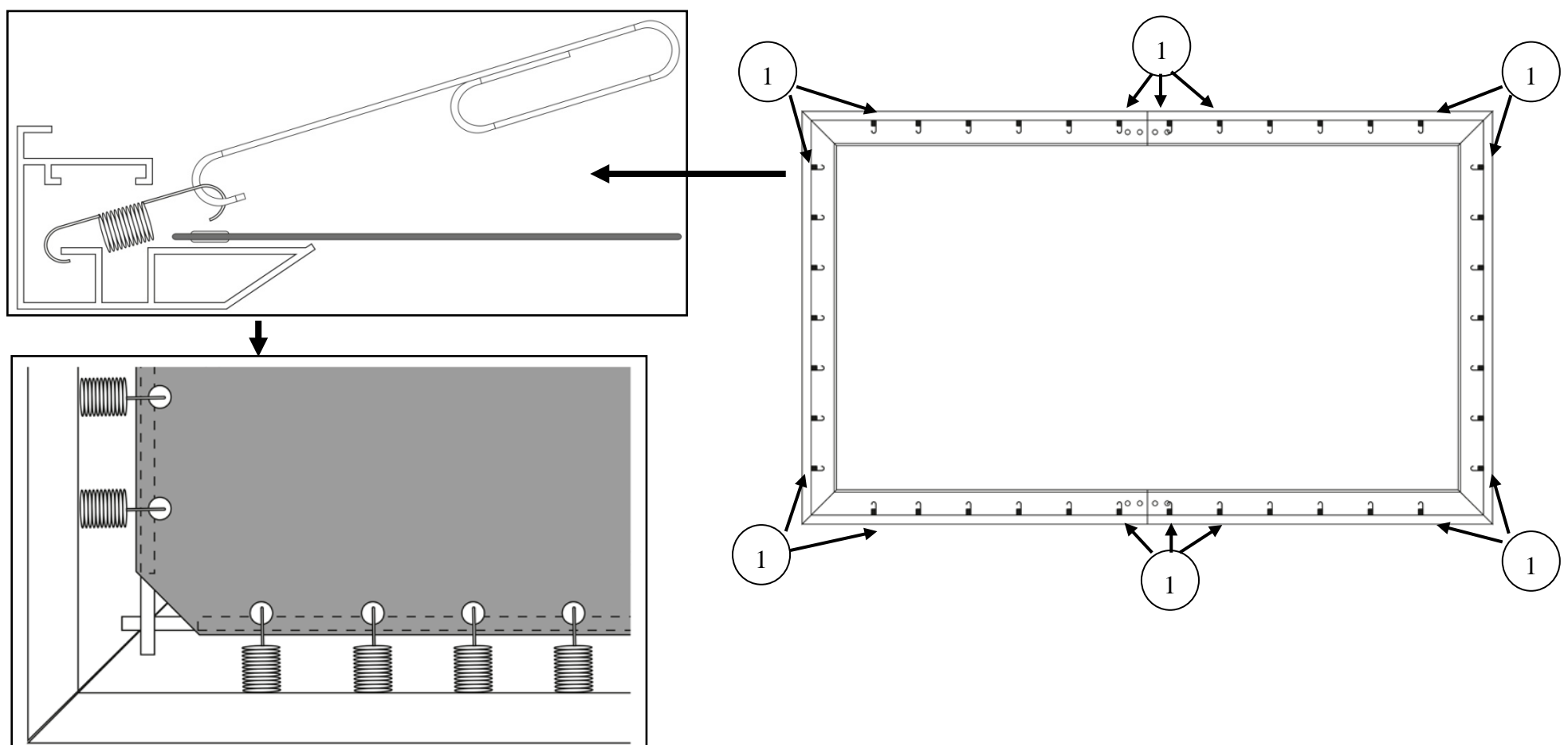

Step 9. Two people are suggested for this step. Place the *Center Support Bar (J)* into the top groove on the back of the frame (not the one where the spring inserts) at the approximate center point of the frame. Carefully pull the bottom horizontal frame outward and place the *Center Support Bar (J)* at the approximate center point of the frame. Carefully release the frame once the bar is centered. (See illustrations below for details.)

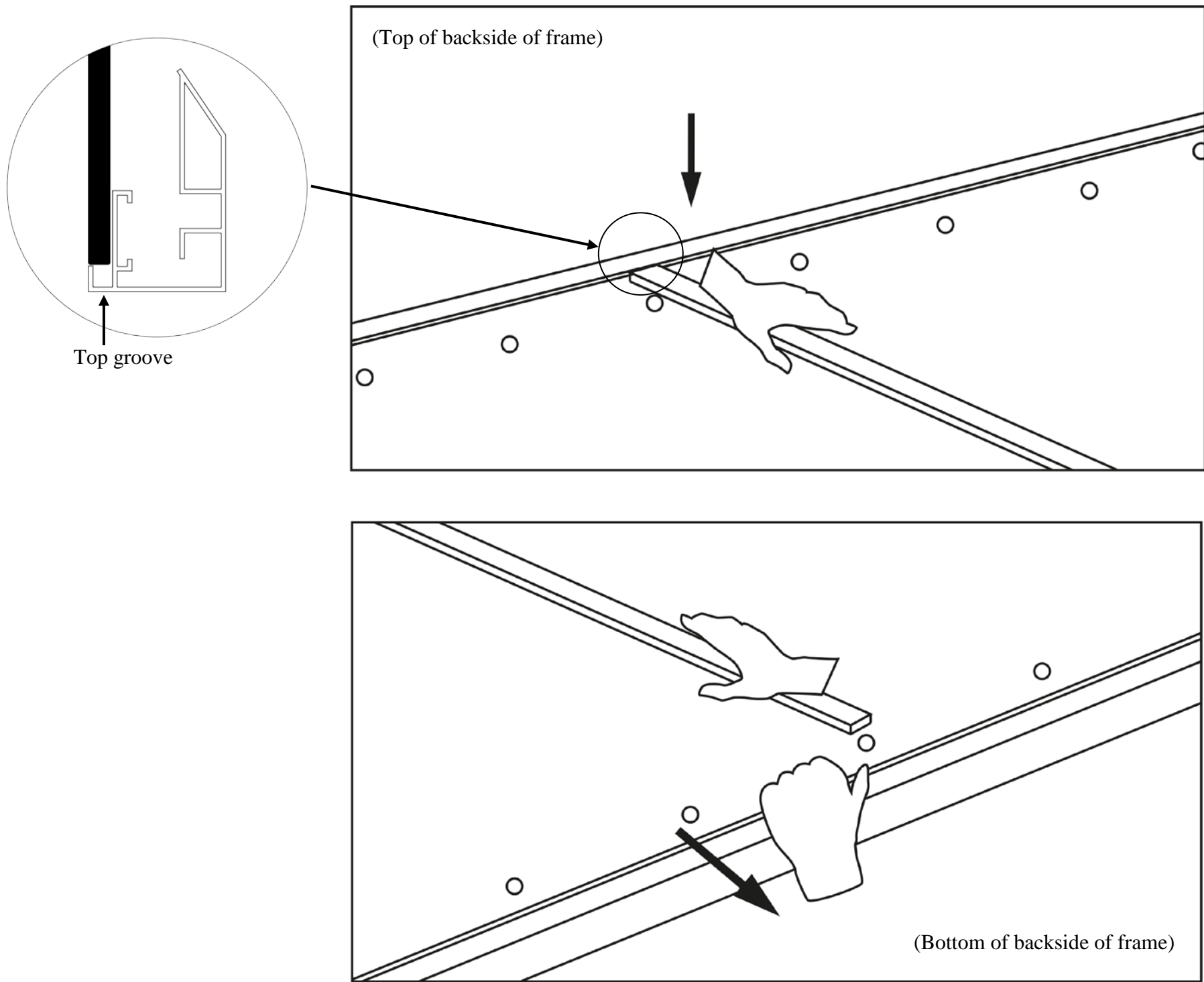

Step 10. After the *Center Support Bar (J)* secure, connect the center of the vertical portions of the material (2). **Be sure to hook the Springs (B) onto the Tension Rod (I) to avoid damage to the screen material.** Next, return to the vertical sides, securing the remainder of the springs (3). Lastly, secure the remaining springs of the horizontal sides of the screen (4).

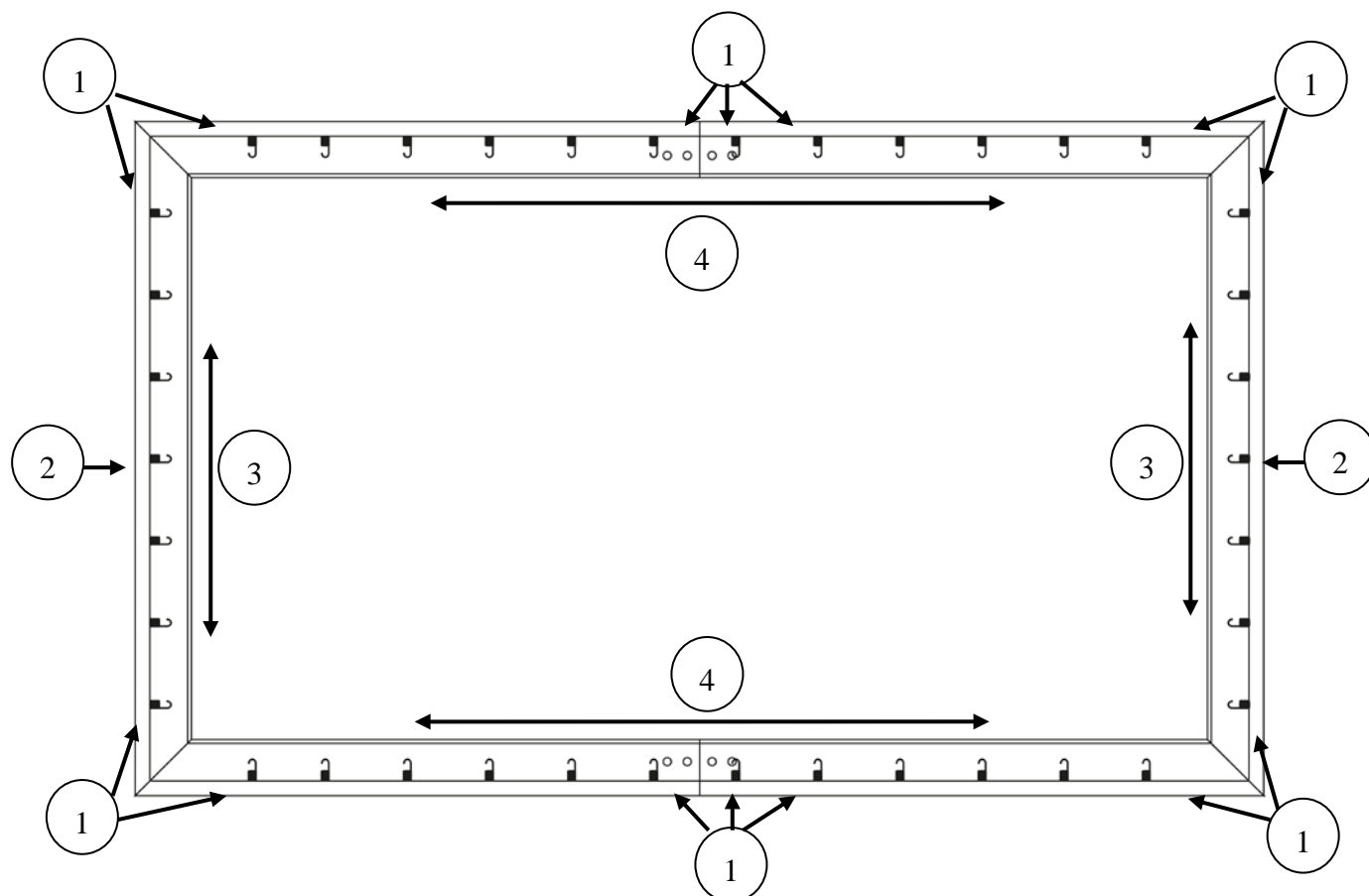

Installation

Step 11. Measure the overall length and height of the frame and drill holes for the *Brackets (F)*. Line up the wall brackets with the drilled holes on the installation location and screw them in using a Phillips screwdriver. If not installing into a structural wood stud, use a hollow wall *Anchor (H)*, then screw in the *M5x50 Screws (H)* with a screwdriver. Make sure the brackets are leveled.

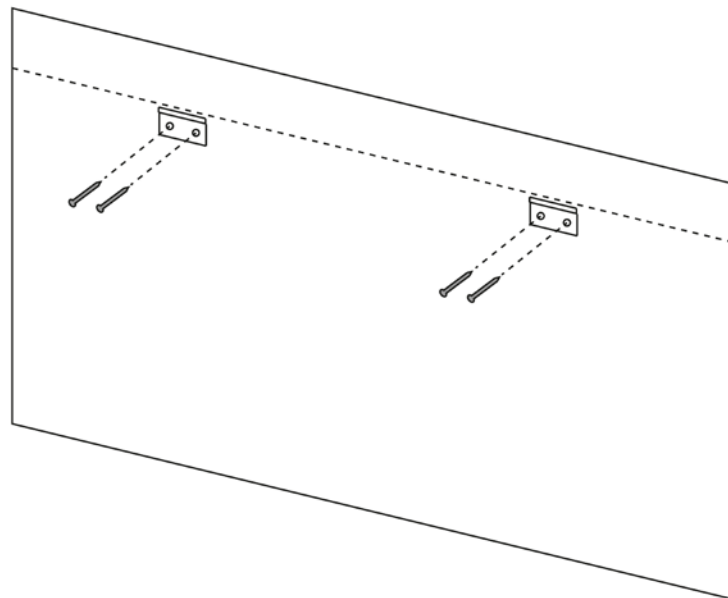

Step 12. Position the fixed frame screen onto the wall *Brackets (F)* as shown below and push down at the center of the top of the frame to secure.

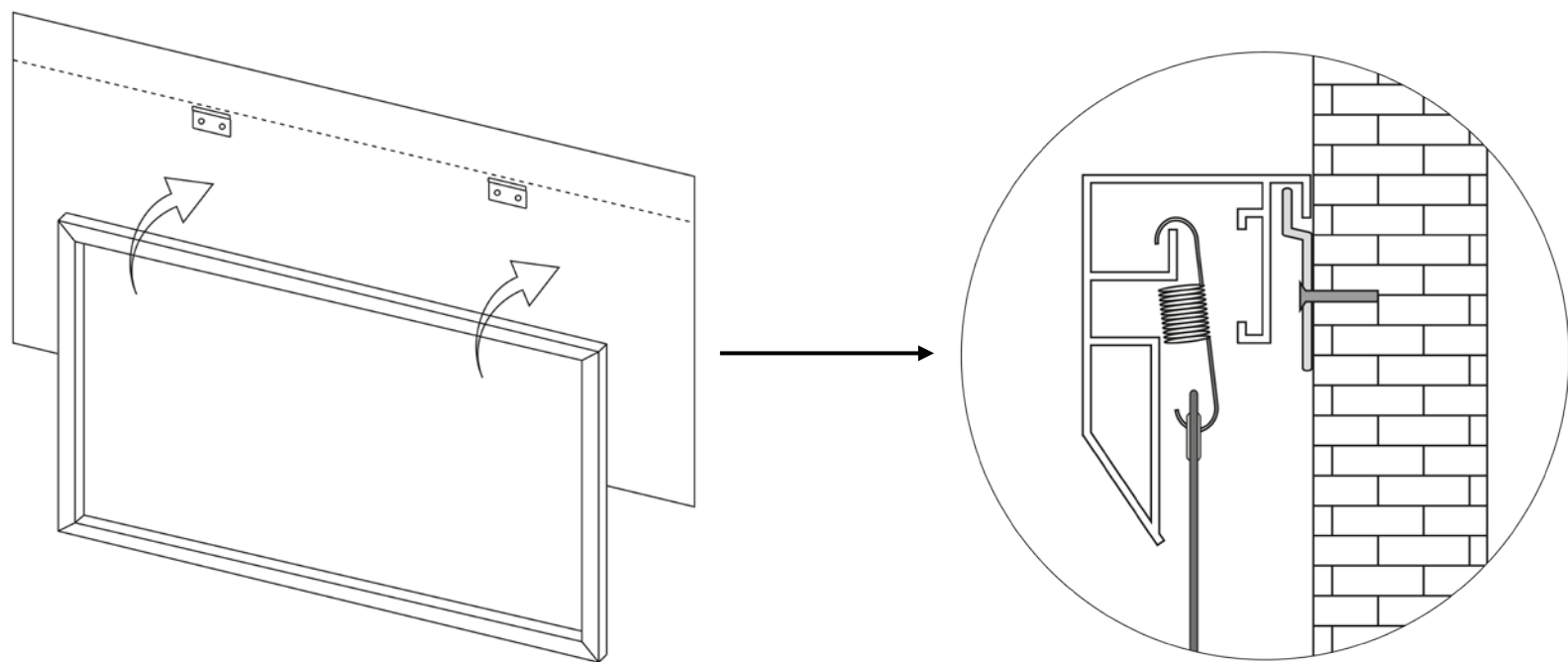

CAUTION

Please follow these instructions carefully to ensure proper maintenance and safety of your Fixed Frame Screen

1. When hanging the screen up, please make sure that no other objects such as power switches, outlets, furniture, ladders, windows, etc. occupy the space designated for your Fixed-Frame screen.
2. Regardless if the screen is hung on or installed into the wall, make sure that the proper mounting anchors are used and that the weight is supported appropriately by a strong and structurally sound surface just as any large and heavy picture frame should.
3. *(Please consult a home improvement specialist for the best advice on installation)*
4. Frame parts are made of high quality velour-surfaced aluminum and should be handled with care.
5. When not in use, cover over the screen with a furniture sheet to protect it from dirt, grime, paint or any other impurities.
6. Spare Parts should be placed out of reach of small children in accordance with household safety guidelines.

If a visual demonstration is needed, Please view our Sable Frame B2 Series assembly video at:

http://www.elitescreens.com/sableframeb2_assembly

OR scan the QR Code below:



For Technical Support or an Elite Screens contact in your area,

please visit www.elitescreens.com