



Kestrel Tab-Tension 2 | CLR[®]/CLR[®]3 Series

Floor Rising Ceiling/Ambient Light Rejecting (CLR[®]/ALR)

Tab-Tensioned Motorized Screen

User's Guide – E/H Type (RC1)

V1.0

Visit www.elitescreens.com for latest updated version.

IMPORTANT SAFEGUARDS

Read these instructions carefully and retain them for future use. If this product is passed to a third party, then these instructions must be included.

Caution:

The screen's Black Bottom Drop is already set to its maximum drop distance. There is NO extra Black Bottom Drop in the roller. Please be aware of this as it will void your warranty with Elite Screens[®]. Unapproved changes or modifications (except for cutting the power cord for hardwire installations) to this unit are prohibited and will void your warranty.

- To avoid damaging the unit, do not use with any unauthorized accessories not recommended by the supplier.
- Handle the unit carefully during transportation to avoid any damages.
- To ensure safe and reliable operation, direct connection to a properly grounded power source is advised.
- The power outlet supplying power to the unit should be close to the unit and easily accessible.
- Do not install the unit on uneven or inclined surfaces.
- Do not put heavy objects on the power cord and position it properly to avoid creating a trip obstacle.
- Never overload the power cord to prevent an electric shock or fire due to a loose contact or a short circuit.
- There are not user serviceable parts in this unit. Do not attempt to disassemble this unit by yourself. No one except authorized technicians can open and make repairs to this unit.
- Make sure the power source this unit is connected to has a continuous power flow.
- If there is need to use an extension cord, make sure the cord has an equal rating as the appliance to avoid overheating.
- Do not handle the power plug when your hands are wet, or your feet are in contact with water.

Do not use this unit under the following circumstances.

- Disconnect the power cord under the conditions of heavy rain, wind, thunder, or lightning.
- Avoid direct Sunshine, rain shower and moisture.
- Keep away from fire sources and high temperature to prevent this device from overheating.
- Cut off the power supply first before transportation or maintenance.
- Fully disconnect from the power supply when the unit is not in use for a long period of time, as should be done with any other electric household appliance.
- To avoid possible injury and/or an electric shock, do not attempt to use the screen if there is obvious damage or if there are any evident broken parts.
- Keep hands clear from the closing panels.
- Keep away from children when screen is in operation.

WARNING

Individual modifications to this product are prohibited and will void the supplier's warranty. Please contact the Elite Screens® Customer Service Team with any questions.

SCREEN MAINTAINANCE

Dust, dirt, and scratches on the projection screen surface will affect the quality and performance of the projection image. For optimal results we advise to pay attention to the following instructions.

1) The screen surface has a horizontal structure. **DO NOT** wipe the screen up and down or in a circular motion.

Wipe very gently when needed from left to right only.

2) Please clean the dust on the screen surface with a soft brush or microfiber cloth (rough towel or cloth may damage the screen's surface).

3) Gently wipe the screen with a lightly moistened microfiber cloth with mild soap diluted in water.

Notes:

The following precautions should be followed at all times to avoid damaging the material, which is not covered under warranty.

- Don't **touch** the screen material to avoid leaving fingerprints. ***Use gloves when handling the material.***
- Don't **scratch** the material, as it will leave permanent markings on the screen's surface.
- Don't **point** to the screen material with a fingertip or other sharp objects to prevent damage to the material.
- Don't use acetone, benzene, alcohol, and any other organic solvents to clean the screen material. Using such chemicals will permanently damage the screen.

FCC Regulatory Compliance

This device complies with Part 15 of the FCC Rules.

Operation is subject to the following two conditions:

(1) this device may not cause harmful interference, and (2) this device must accept any interference received, including interference that may cause undesired operation.

Changes or modifications not expressly approved by the party responsible for compliance could void the user's authority to operate the equipment.

This equipment has been tested and found to comply with the limits for a Class B digital device, pursuant to Part 15 of the FCC Rules. These limits are designed to provide reasonable protection against harmful interference in a residential installation. This equipment generates, uses, and can radiate radio frequency energy and, if not installed and used in accordance with the instructions, may cause harmful interference to radio communications. However, there is no guarantee that interference will not occur in a particular installation.

If this equipment does cause harmful interference to radio or television reception, which can be determined by turning the equipment off and on, the user is encouraged to try to correct the interference by one or more of the following measures:

- Reorient or relocate the receiving antenna.
- Increase the separation between the equipment and receiver.
- Connect the equipment into an outlet on a circuit different from that to which the receiver is connected.
- Consult the dealer or an experienced radio/TV technician for help.

This equipment complies with FCC radiation exposure limits set forth for an uncontrolled environment. This transmitter must not be co-located or operating in conjunction with any other antenna or transmitter.

PARTS IDENTIFICATION



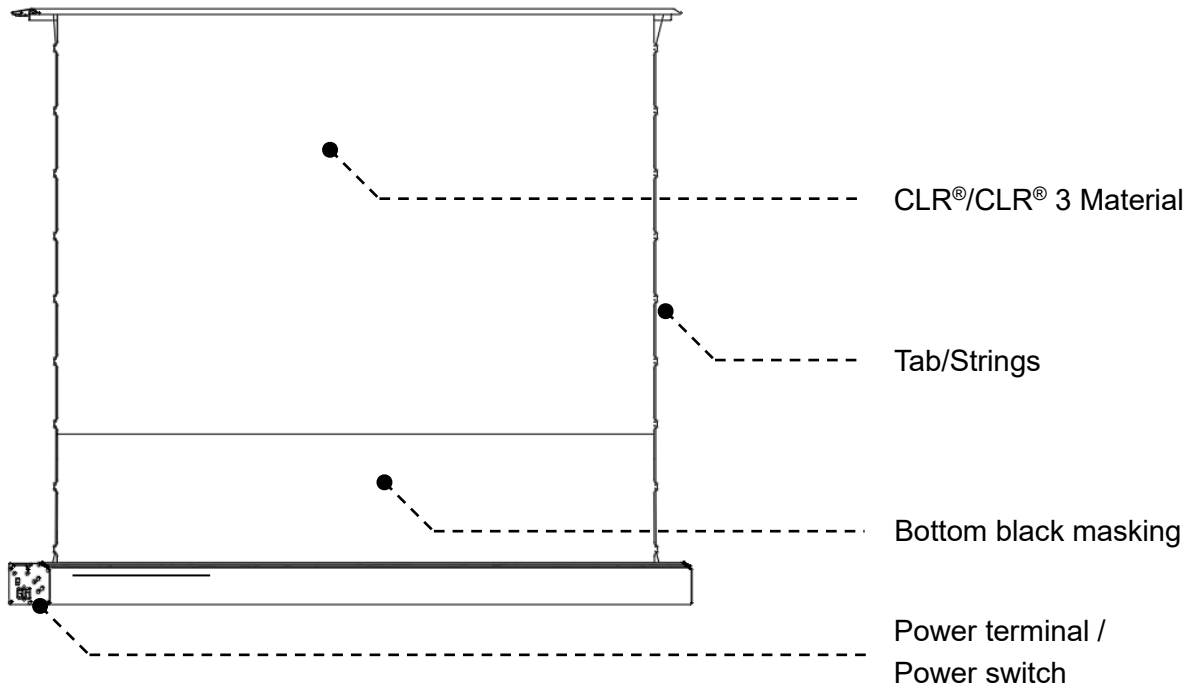

Front of screen

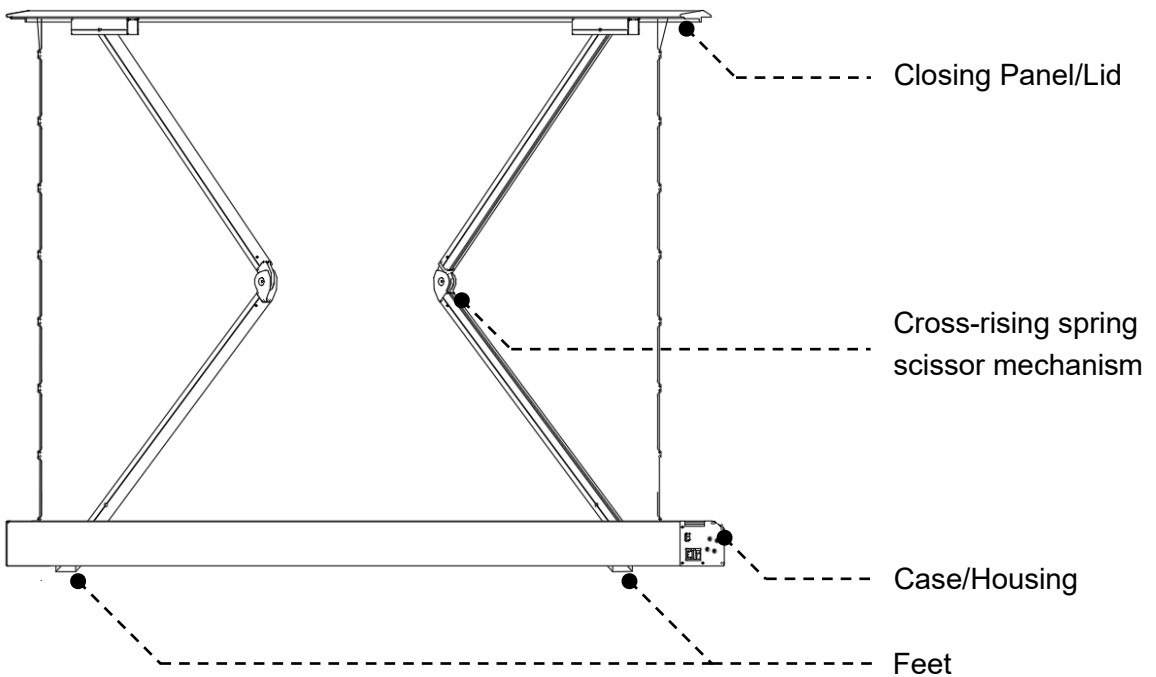

Back of screen

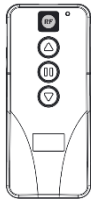

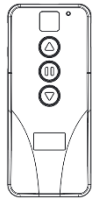
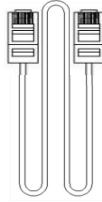
Note: Please always store the screen flat horizontally. Never store the screen in a vertical position as it will permanently damage the screen's structure, shift the material, and cause wrinkles/folds which will void the warranty.

Kestrel Tab-Tension 2 Controls and Accessories				
A. IR (InfraRed) Remote Control ZRC1-IR	B. RF (Radio Frequency) Remote control ZRC1-RF	C. Wall box controller ZRC1-WB	D. RJ50 Cable ZRC1-RJ50	E. AAA batteries
			* Pre-installed inside housing 	

SCREEN OPERATION

Electric Current: Depending on your region, the screen will operate in either 110v or 220v voltage.

1. After ensuring the power outlet & screen are compatible (voltage), plug the power cord into the power outlet.
2. Once the screen has power, you'll be able to control it using any of the **5 methods** described below.

5 ways to control your Kestrel Tab-Tension 2 Screen

1. **IR Remote Control (Item A, Fig.1):** The Infrared functions by direct line of sight contact using an effective beam range of 25 feet within a 30-degree angle. Aim the IR remote directly at either the IR receiver on the Wall Box Controller or on the screen to operate the screen.

Note: Assure there is no obstruction between the IR remote and IR receiver.

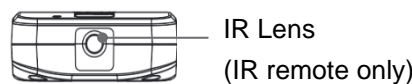

2. **RF Remote Control (Item B, Fig.1):** The radio waves eliminate the need for a direct line of sight and has a longer distance control range.

The RF remote is already pre-synced/paired and ready to use. If synchronization/ pairing is needed, please follow the steps below.

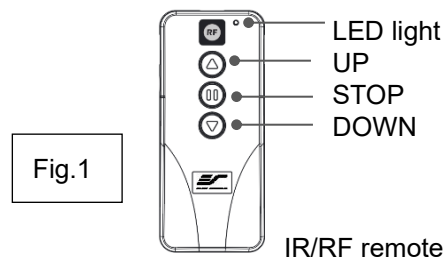

How to synchronize/pair a new RF remote:

- Press & hold the “**Programming Key**”, then press the “**Up Key**” on the **Wall box controller** (wall-box LED flashes). **Reference the wall box controller section for programming key location.**
- Then press the “**Up Key**” on the **RF remote**.
The **Wall box** LED will flash 5 times, to indicate the RF remote has been properly synchronized/paired.

How to change the RF code (For use when multiple screens/RF remotes are owned, Fig.2)

Changing the RF code avoids controlling multiple screens at the same time and prevents electrical interference leading to accidental control of the screen.

1. Remove the batteries
2. Change the RF code switch
3. Insert the batteries
4. Synchronize it with the wall box controller

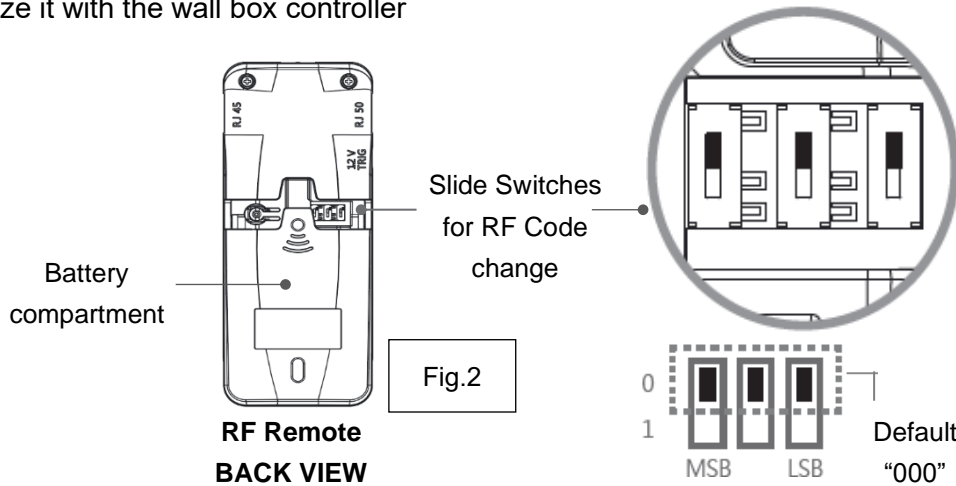

3. Wall box controller (Item C, Fig.3): The wall box controller switch is a wall mounted control box with an up/stop/down button. The RJ50 cable is pre-installed inside the housing. Plug the other RJ50 end to the wall box controller. (Item D).

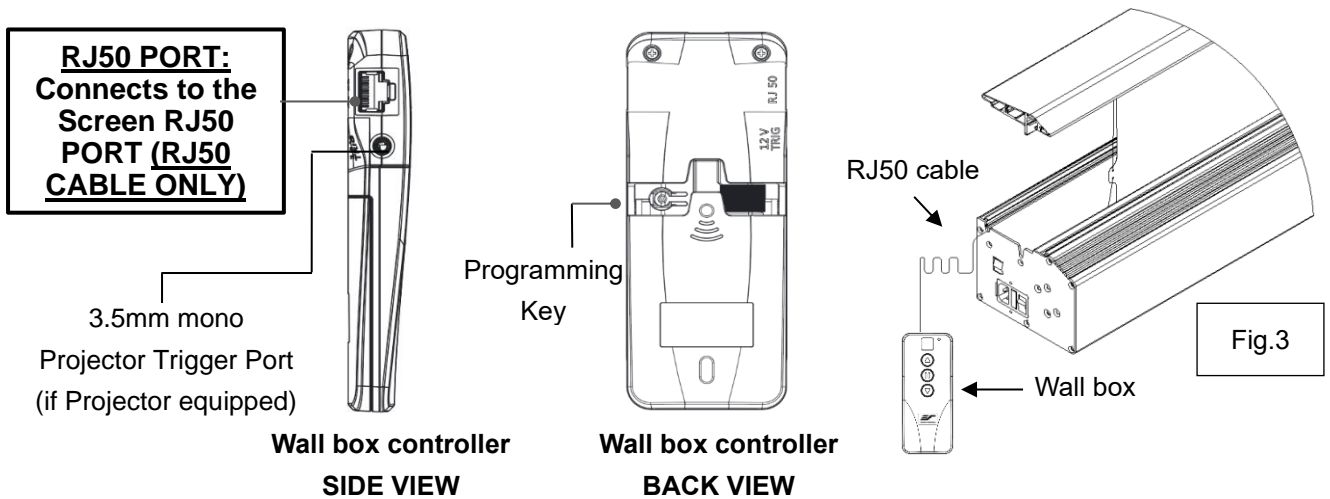

4. Wired 5-12 volt trigger (Fig.4): Requires a 3.5mm to 3.5mm mono cable (**Not included**)

Step 1: Connect the RJ50 cable that is pre-installed inside the housing to the to the Wall box controller.

Step 2: Then connect one end the 3.5mm mono cable to the wall box controller and the other to the projector.

Once the two cables have been connected, the wired trigger feature is ready to synchronize the screen's up/down operation with the projector's power cycle.

- Projector on, screen drops
- Projector off, screen raises

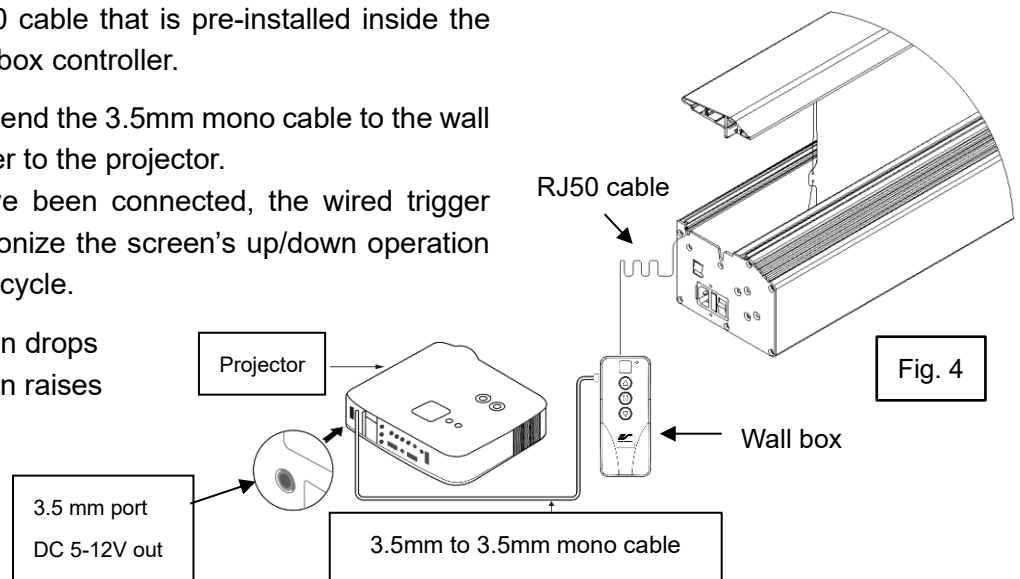

5. Wireless 5-12 volt trigger (Fig.5): Requires a 3.5mm to 3.5mm mono cable (**Not included**).

The Radio Frequency (RF) remote control serves as a dual purpose, independently as a handheld remote control, or as a Wireless 5-12 volt trigger. The radio frequency technology sends a wireless signal that synchronizes the screen's drop & rise with the projector's power cycle.

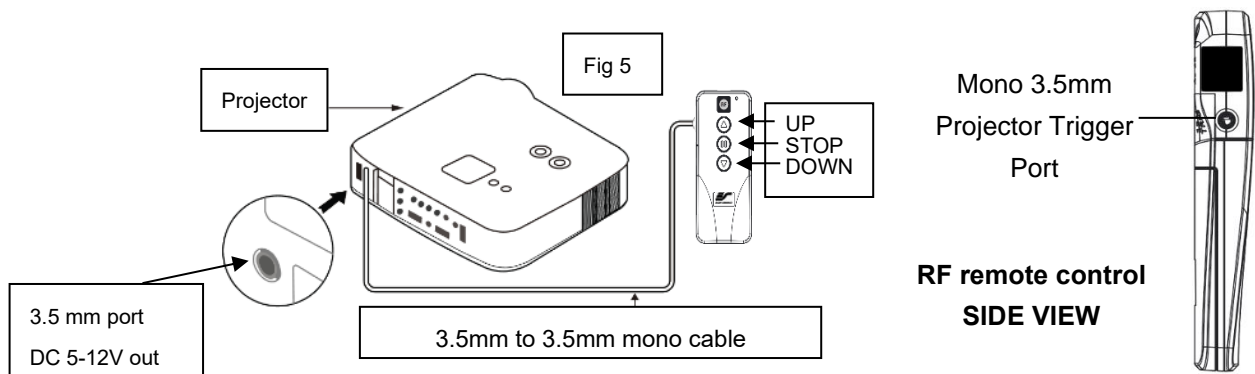

Here's how to set up your Wireless 5-12 volt trigger

The 5-12V wireless trigger should already be synced and ready to work.

Step1: Connect one end of the 3.5 mm mono trigger cable to the RF remote. 

Step 2: Connect the other 3.5 mm mono end of the cable to your projector 

Step 3: Turn on the projector and the screen should automatically deploy.

Step 4: Turn off your projector and the screen should automatically retract.

(Please be aware, the projector on/off cycle may take longer to fully activate. It usually takes around 20-30 seconds for full off and on cycle each time)

Note: If the wireless trigger feature does not work, please resync the RF remote to the Wall box controller per the instructions in the Radio Frequency remote section.

ADVANCED Programming Key Instructions: (FOR ADVANCED USERS ONLY)

Wall box controller must be connected to the screen.

ATTENTION: Reducing the factory's full screen drop may produce waves/wrinkles on the projection surface on tab-tension screens. The full drop is recommended to allow the screen to rely on the tab-tension system to maintain the projection surface flat and taut on all sides.

The same applies on non-tensioned screens, although some level of waves may be present due to the nature of the screen not being tensioned. If wrinkles/waves develop after making the adjustment to the desired drop position, reset it to the factory's default position per the instructions below.

FLATNESS AFFECTED BY NEW PROGRAMMED VERTICAL POSITION IS NOT COVERED UNDER A REPLACEMENT WARRANTY.

1. Preset the Screen's Drop Position:

Use the RF/IR remote or Wall Box Controller to Drop the screen to the desired position you want to set it at. Press & hold the "Programming Key", then press the "Down key" on the Wall Box Controller. The LED will flash 5 times to confirm new programmed drop position.

PROGRAMMING NOTE:

The programmed vertical position relies on a time-count which adjusts itself according to the programmed timed difference. Multiple up/down programming will result in the vertical position being off a few inches. It is recommended that programming is done the **first-time** the desired vertical position is determined or RESET it to factory default and programming the desired vertical position afterwards.

2. Clear/Reset the Screen's Drop Position to factory default:

Press & hold the "Programming Key + "Stop key" on the wall box controller.

Notice to Installer:

PROPER PROJECTOR PLACEMENT

The CLR® /CLR® 3 is exclusively for tabletop/bottom mounted ultra-short throw projectors. See illustrations below for limits and criteria.

1) Tabletop mounted ultra-short throw projection illustration

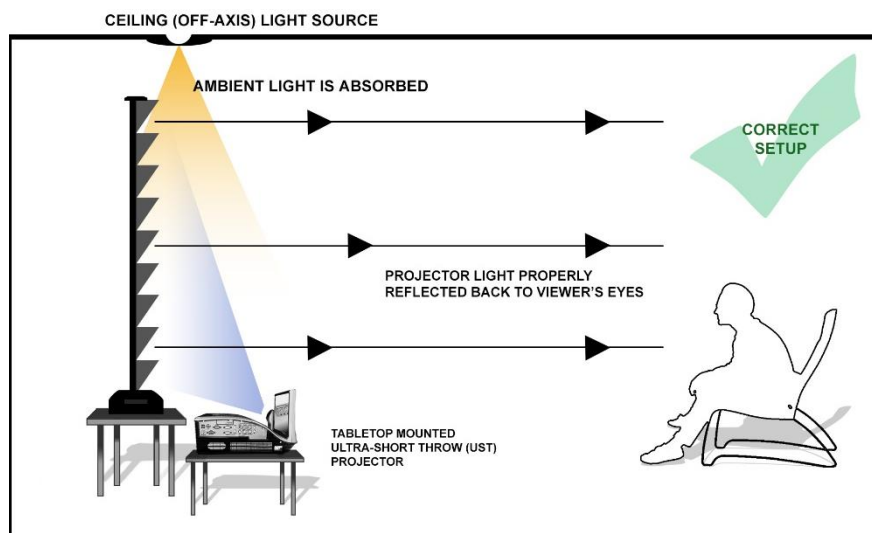

IMPROPER PROJECTOR PLACEMENT

Overhead placement or a standard throw projector will make the image very dark on account of the screen's absorbent layer deflecting light that is not aligned with its reflective angle.

1) Ceiling mounted Ultra-short throw projector illustration

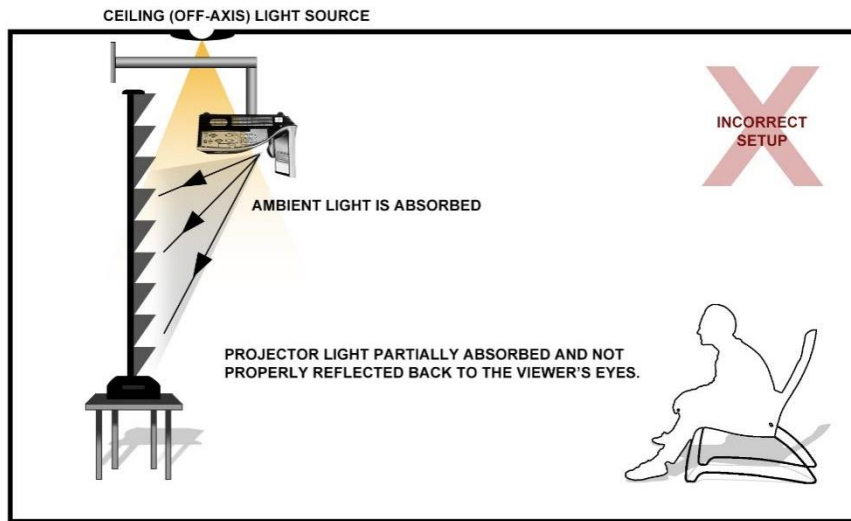

2) Ceiling mounted Short and Standard throw Projector Illustration

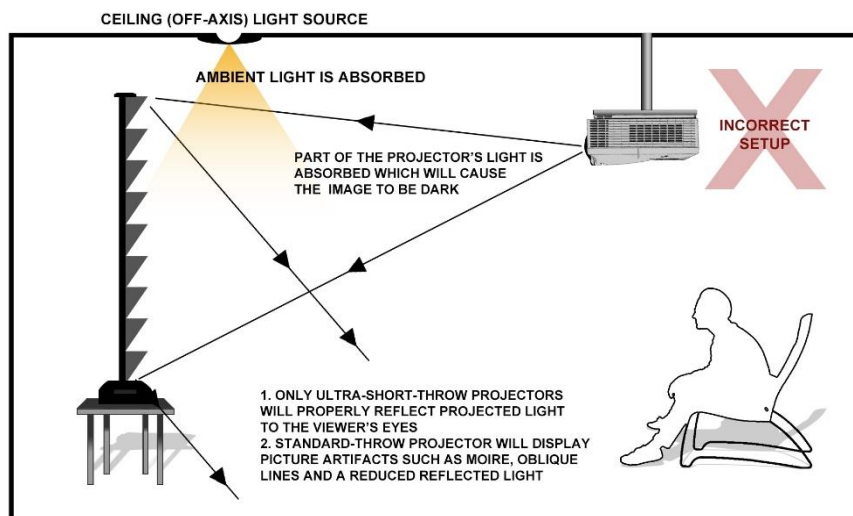

Note: Images are not up to scale and are for illustrations purposes only

For more information, technical support or your local Elite Screens® contact,

please visit <http://www.elitescreens.com/>