



Saker Tab-Tension AcousticPro UHD Series

Acoustically Transparent Electric/Motorized Projection Screen

User's Guide – EH Type (RC1)

V1

Visit www.elitescreens.com for the latest updated version.

Product Description

The *Saker Tab-Tension AcousticPro UHD* by Elite Screens® is an acoustically transparent (AT) Ultra-Hi-Def electric/motorized projection screen. Its *AcousticPro UHD* front projection material is designed to complement in-wall speakers while allowing sound to pass through the material with minimal attenuation. It accomplishes superior video performance with negligible loss in sound propagation due to its tight perforated weave fabric.

Screen Maintenance

Dust, dirt and scratches on the projection screen surface will affect the quality and performance of the projection image. For optimal results we advise to pay attention to the following instructions.

- Use a dry microfiber cloth or soft brush to remove dust from the screen's surface.
- When cleaning, use a damp microfiber cloth with warm water to remove any marks.
- Never rub or apply pressure when cleaning the surface.
- Don't **point** to the screen material with a fingertip or other sharp objects to prevent damage to the material.
- Don't **scratch** the material, as it will leave permanent markings on the screen's surface.
- Don't **use** acetone, benzene, alcohol and any other organic solvents to clean the screen material. Using such chemicals will permanently damage the screen.

Notes: The following precautions should always be followed to avoid damaging the material, which is not covered under warranty.

Important Safety & Warning Precautions

Make sure to read this user's guide and follow the procedures below.

CAUTION: Unapproved changes or modifications (except for cutting the power cord for hardwire installations) to this unit are prohibited and will likewise void your warranty. For more information, please contact our Technical Support Department at techsupport@elitescreens.com.

- Please retain this user's guide for future reference.
- To avoid damaging the unit, do not use with any unauthorized accessories not recommended by the supplier.
- Handle the unit carefully during transportation to avoid any damages.
- To ensure safe and reliable operation, make sure the power connection is secure.
- The power source should be close to the unit and easily accessible.
- Do not install the unit on uneven, or inclined surfaces;
- To avoid electrical shock or product damage, do not install this device in a damp place.
- Do not place any heavy objects over the power cord.
- Position the power cord properly to avoid creating a trip hazard.
- Avoid electrical shock or fire, by not overloading the power cord.
- The internal & external parts of this unit are not end user serviceable. Do not attempt to disassemble this unit by yourself. Consult an authorized technician instead.
- Make sure the power source that this unit is connected to has a continuous power flow.
- If there is need to use an extension cord, make sure said cord has a compatible power rating.
- Do not handle this or any other electrical device if you are wet or standing in water.
- Whenever the screen reaches its end of life, follow local environmental guidelines regarding its proper disposal.

Do not use this unit under the following circumstances.

- Disconnect the power cord if exposed to moisture, rain, wind, electrical storms or snow.
- Avoid exposure to direct sunlight or any of the conditions stated in the previous bullet point.
- Keep away from fire or other high temperature heat sources.
- Cut off the power supply first before attempting maintenance or removal.
- Do not attempt to use this screen if there are obvious signs of damage.
- To avoid possible injury and/or an electric shock, do not attempt to use the screen if there is obvious damage or if there are any evident broken parts.

WARNING

The Screen's **Top Black Drop** is already set to its maximum drop distance. There is **NO** extra top black drop in the roller. Please be aware of this as it will void your warranty. Individual modifications to this product are prohibited and will void the supplier's warranty. Please contact the EPV Screens Customer Service Team with any questions.

NOTE: This equipment has been tested and found to comply with the limits for a Class B digital device, pursuant to Part 15 of the FCC Rules. The product settings are designed to provide reasonable protection against any radio interference within a residential installation, however the screen may suffer from Radio Frequency interference from other home electronics.

Although radio interference affecting other household electronics is unlikely, the following steps can be taken should RF interference occur.

- ✓ **Reorient or relocate the receiving antenna on the device that may be causing the interference.**
- ✓ **Increase the distance between the screen and the interfering device's receiver.**
- ✓ **Connect the projection screen to another power source apart from the interfering device.**





Pre-Installation

1. Carefully unpack the screen.
2. Always handle the screen upright on a clean, level surface.
3. Keep the screen out of contact with foreign particles such as dust, sawdust, and/or liquids.

NOTE: Regardless of the mounting method, each screen should be securely installed so that vibrations or pulling on the viewing surface will not cause the casing to become loose or fall. Included are complimentary mounting screws that may or may not be appropriate for the installation you are attempting. Always use the correct anchors to safely secure the screen and always consult a professional integrator.

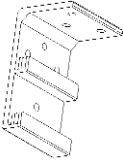
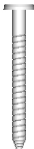
Hardware Parts List

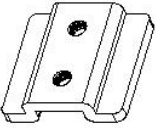
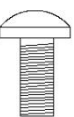
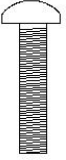
Please make sure all parts listed below are included before proceeding with the installation.

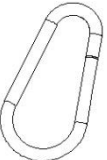
| A. Wall/Ceiling mount bracket x2 | B. M5x60 Screw x6 | C. M12 Dry-wall anchor x6 | D. Bracket connector x2 (Installed on the housing) | E. M5x11 Bolt Screw x4 (Attached to Part D) | F. M5x25mm round head cross screws x2 | G. M5x30mm eyebolt screw & M5 nut x2 | H. Carabiner x 2 |
|---|---|---|---|---|---|---|---|
|  |  |  |  |  |  |  |  |

Installation Instructions

For installation assistance, please consult a professional Installer. Elite Screens is not liable for faulty installations. Two or more people are required while one holds the screen in place.

A. Wall Mount

Flush mount (movable position)

This mount method allows the screen to slide horizontally.

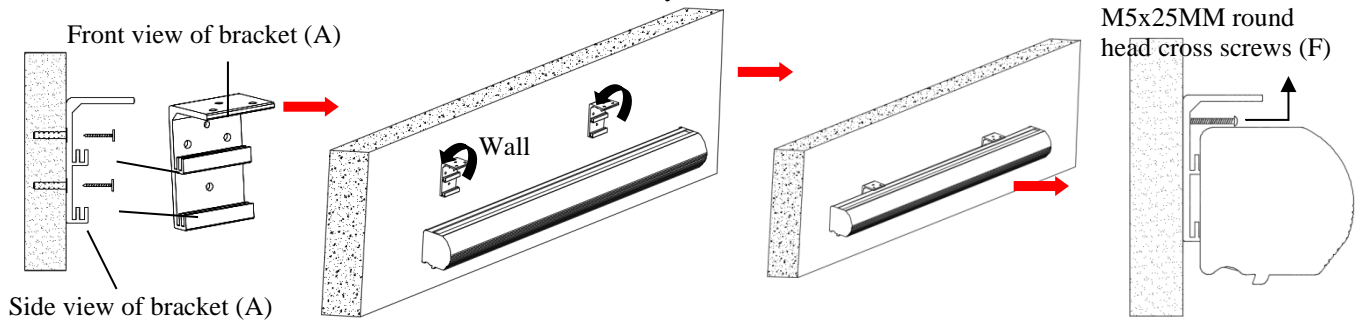

1. Determine where the screen will be installed. Then, measure and mark the distance between the top and bottom screw holes from each **Wall/Ceiling mount bracket (A)**.
2. Drill a hole on all marked points and install the brackets with the **dry-wall anchor(C)**, **M5x60 screw (B)**, Make sure both brackets are properly leveled.
3. Hang the screen by placing the **lower** “catch” located on the back over the brackets **upper** “catch”.
4. After making sure the screen is secured, you can slide it left / right to properly center it in position.
5. Lastly, screw the **M5 screw (F)** into the upper hole of the bracket to add additional support for the screen.

B. Ceiling Mount

I. Ceiling Mount (movable position)

This mount method allows the screen to slide horizontally.

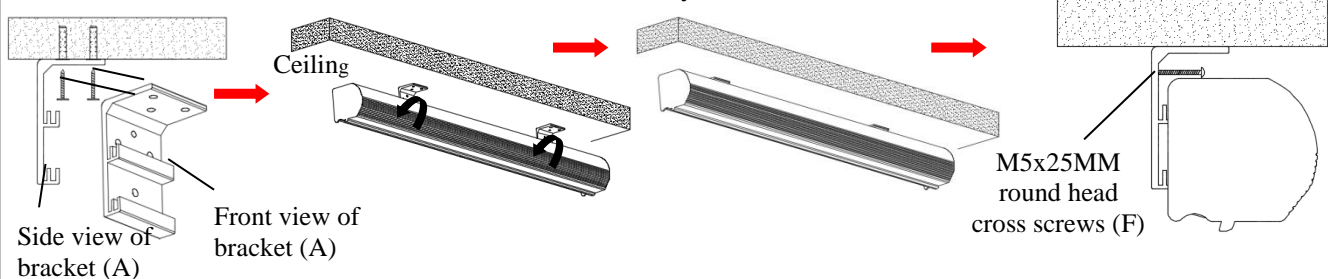

1. Determine where the screen will be installed. Then, measure and mark the distance between the top and bottom screw holes from each **Wall/Ceiling mount bracket (A)**.
2. Drill a hole on all marked areas and install the brackets with the **dry-wall anchor(C)**, **M5x60 screw (B)**, Make sure both brackets are properly leveled.
3. Hang the screen by placing the **lower** “catch” located on the back over the bracket’s **upper** “catch”.
4. After making sure the screen is secured, you can slide it left / right to properly center it in position.
5. Lastly, screw the **M5 screw (F)** into the upper hole of the bracket to add additional support for the screen.

II. Suspended

1. Screw the **eyebolt (G)** onto the **bracket connector (D)**.
2. Attach the **snap link (H)** through the **eyebolt (G)** and connect it to the ceiling eyebolt screw (not included) as rated for the screen’s weight.

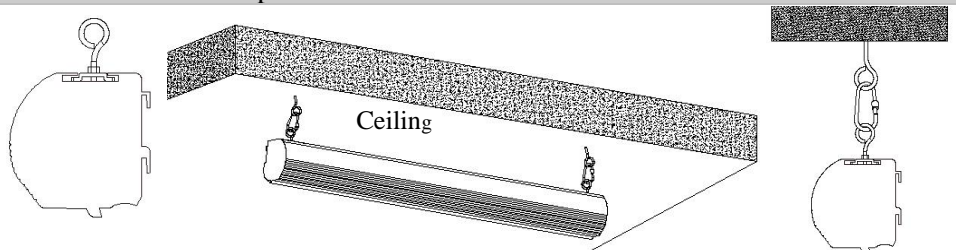

Screen material tension adjustment

(4mm Allen Wrench required and not included)

Remove the weight bar end cap to expose the adjustment tension knob. This knob has a 4mm Allen port. Insert your 4mm Allen Wrench and push in the adjustment tension knob, turn clockwise and your screen will gain more tension. Turn the Allen Wrench counterclockwise and the screen will lose tension. Please note this adjustment is not necessary as the tension of the screen has been pre-set to its factory drop setting. If you would like to adjust the screen tension, please contact Elite Screens® for assistance to avoid damaging the screen and voiding your warranty.

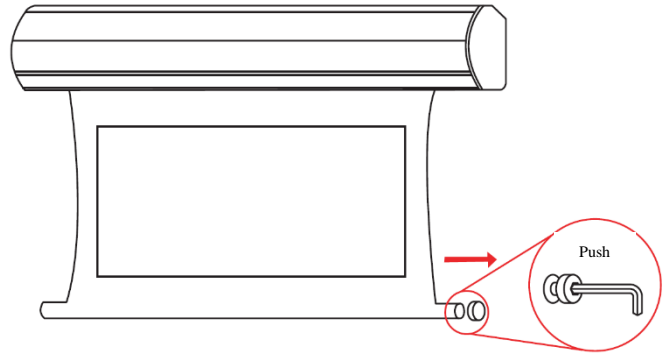

| Saker Tab-Tension AcousticPro UHD Controls and Accessories | | | | | |
|--|-------------------------|--------------------------------------|----------------------------|---------------------|-------------------|
| A. IR Remote ZRC1-IR | B. RF Remote ZRC1-RF | C. Wall box controller ZRC1-WB | D. RJ50 cable ZRC1-RJ50 | G. AAA batteries | H. Bubble leveler |
| | | | | | |

Screen operation

Electric Current: 110v

1. After ensuring the power outlet & screen are compatible (voltage), plug the power cord into the power outlet.
2. Once the screen has power, you will be able to control it using any of the 5 methods described below.

5 Ways to control your screen

1. IR Remote control (Item A, Fig 1): The Infrared functions by direct line of sight contact using an effective beam range of 25 feet within a 30-degree angle. Aim the IR remote directly at either the IR receiver on the Wall Box Controller or on the screen to operate the screen.

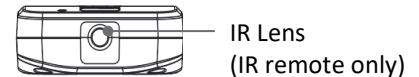

Note: Assure there is no obstruction between the IR remote and IR receiver.

2. RF Remote Control (Item B): The radio waves eliminate the need for a direct line of sight and has a longer distance control range.

The RF remote is already pre-synced/paired and ready to use. If synchronization/ pairing is needed, please follow the steps below.

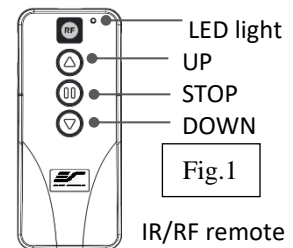

How to synchronize/pair a new RF remote:

- Press & hold the “**Programming Key**”, then press the “**Up Key**” on the **Wall box controller** (wall-box LED flashes). *Reference the wall box controller section for programming key location.*
- Then press the “**Up Key**” on the **RF remote**.
- The **Wall box** LED will flash 5 times, to indicate the RF remote has been properly synchronized/paired.

How to change the RF code (For use when multiple screens/RF remotes are owned)

Changing the RF code avoids controlling multiple screens at the same time and prevents electrical interference leading to accidental control of the screen.

1. Remove the batteries
2. Change the RF code switch
3. Insert the batteries
4. Synchronize it with the wall box controller

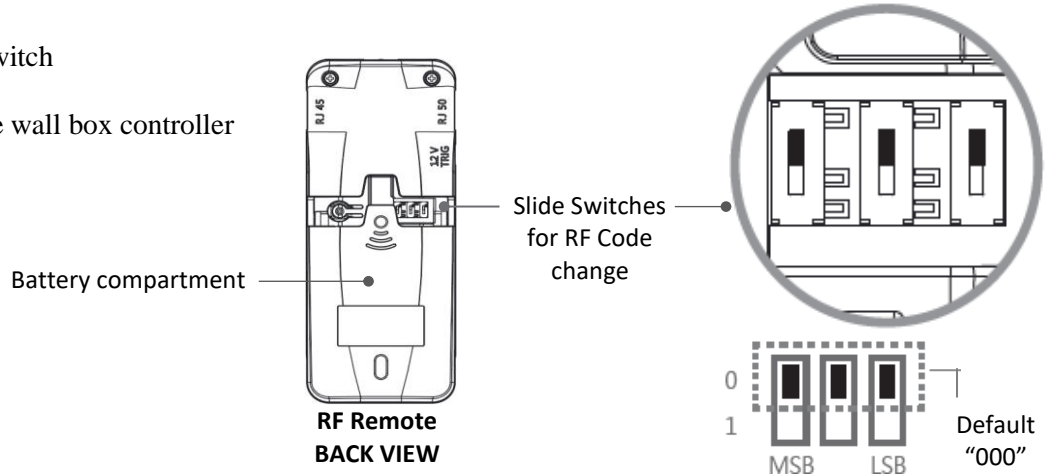

3. Wall box controller (Item C, Fig 3): The wall box controller switch is a wall mounted control box with an up/stop/down button. It plugs directly into the screen's RJ50 port.

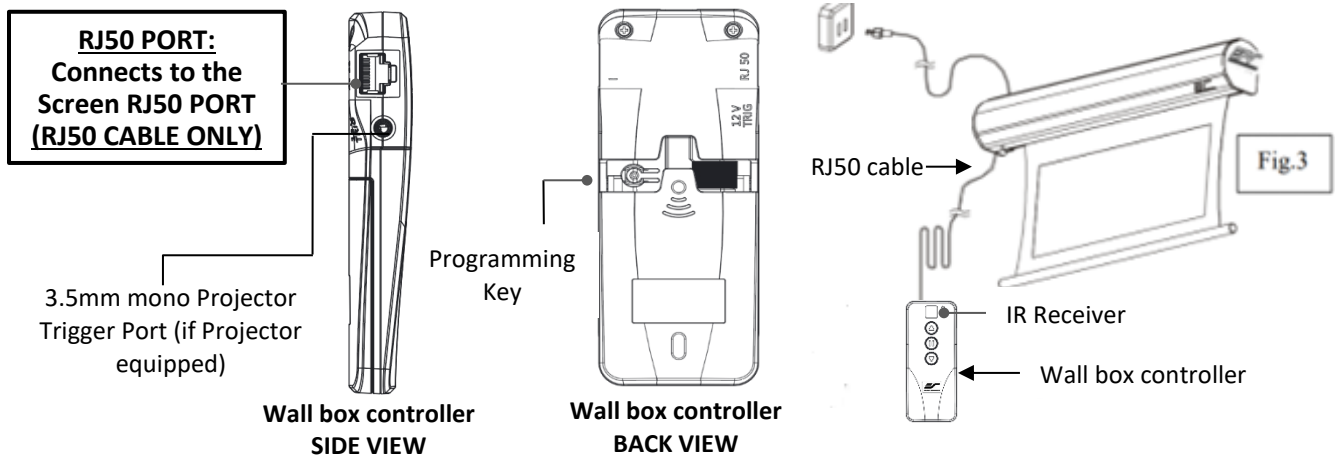

4. Wired 5-12 volt trigger: Requires a 3.5mm to 3.5mm mono cable (not included)

Step 1: Connect one end the RJ50 cable to the screen and the other end to the Wall box controller.

Step 2: Then connect one end the 3.5mm mono cable to the wall box controller and the other to the projector.

Once the two cables have been connected, the wired trigger feature is ready to synchronize the screen's up/down operation with the projector's power cycle.

- Projector on, screen drops
- Projector off, screen raises

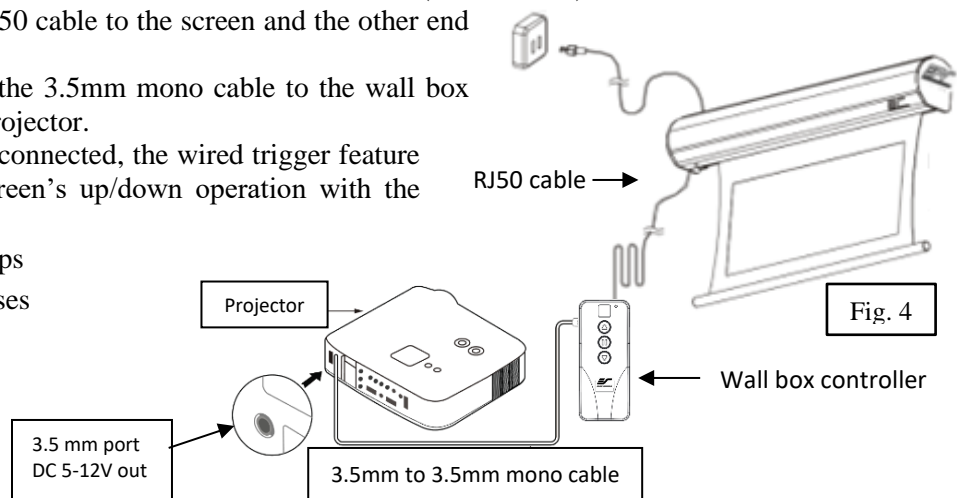

5. Wireless 5-12 volt trigger (Fig 5): Requires a 3.5mm to 3.5mm mono cable (not included).

The Radio Frequency (RF) remote control serves as a dual purpose, independently as a handheld remote control, or as a Wireless 5-12 volt trigger. The radio frequency technology sends a wireless signal that synchronizes the screen's drop & rise with the projector's power cycle.

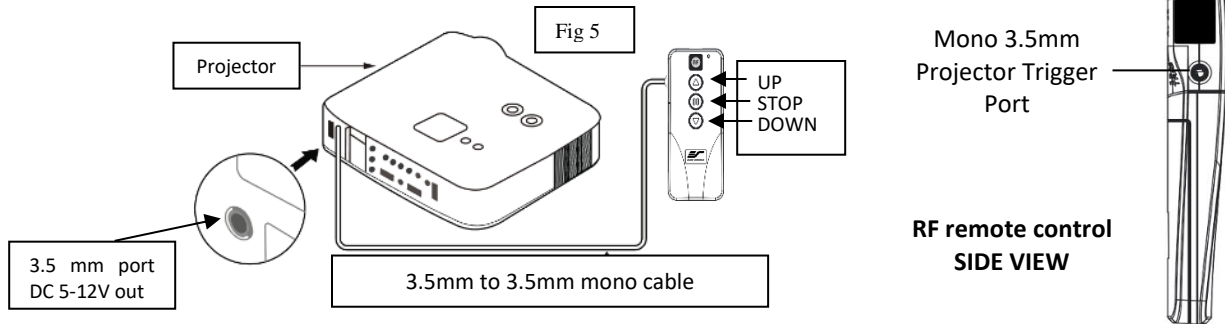

Here's how to set up your Wireless 5-12 volt trigger

The 5-12V wireless trigger should already be synced and ready to work.

Step 1: Connect one end of the 3.5 mm mono trigger cable to the RF remote.

Step 2: Connect the other 3.5 mm mono end of the cable to your projector

Step 3: Turn on the projector and the screen should automatically deploy.

Step 4: Turn off your projector and the screen should automatically retract.

(Please be aware, the projector on/off cycle may take longer to fully activate. It usually takes around 20-30seconds for full off and on cycle each time)

Note: If the wireless trigger feature does not work, please resync the RF remote to the Wall box controller per the instructions in the Radio Frequency remote section.

ADVANCED Programming Key Instructions: (FOR ADVANCED USERS ONLY)

Wall box controller must be connected to the screen.

ATTENTION: Reducing the factory's full screen drop may produce waves/wrinkles on the projection surface on tab-tension screens. The full drop is recommended to allow the screen to rely on the tab-tension system to maintain the projection surface flat and taut on all sides.

The same applies on non-tensioned screens, although some level of waves may be present due to the nature of the screen not being tensioned. If wrinkles/waves develop after making the adjustment to the desired drop position, reset it to the factory's default position per the instructions below.

FLATNESS AFFECTED BY NEW PROGRAMMED VERTICAL POSITION IS NOT COVERED UNDER A REPLACEMENT WARRANTY.

1. Preset the Screen's Drop Position:

Use the RF/IR remote or Wall Box Controller to Drop the screen to the desired position you want to set it at. Press & hold the "**Programming Key**", then press the "**Down key**" on the Wall Box Controller. The LED will flash 5 times to confirm new programmed drop position.

PROGRAMMING NOTE:

The programmed vertical position relies on a time-count which adjusts itself according to the programmed timed difference. Multiple up/down programming will result in the vertical position being off a few inches. It is recommended that programming is done the **first-time** the desired vertical position is determined or RESET it to factory default and programming the desired vertical position afterwards.

2. Clear/Reset the Screen's Drop Position to factory default:

Press & hold the "**Programming Key** + "**Stop key**" on the wall box controller.

For more information, technical support or your local Elite Screens contact, please visit

www.elitescreens.com