



Yard Master Electric Series

Outdoor Electric Movie Projector Screen

User's Guide

E- Type / Version 3.0

*Thank you for choosing the **Yard Master Electric** projection screen! Please read through this user guide before utilizing the screen. Correct usage and maintenance will ensure a long product life.*

Product Description:

The **Yard Master Electric** is an outdoor projector screen for wall and patio installations that brings media room quality to your outdoor spaces. Its sleek aluminum casing beautifully accessorizes your backyard, patio, pool deck or anywhere a gathering for evening movie time is appropriate.

Outdoor Projection Screen Disclaimer

Never leave your projection screen out and exposed to direct sunlight. Regardless of screen brand, prolonged exposure to the sun's ultraviolet radiation degrades the chemical bonds causing the material to eventually decompose. Photo degradation first causes the material to lose its theater-grade reflective qualities. Eventually nature will destroy even synthetic materials. For this reason, the **Yard Master Electric** has a retractable design that allows the material to be drawn up into its protective casing to be shielded from solar radiation.

Care & Use Instructions

◆ Dust, dirt and scratches on the projection surface will affect the picture quality, please take note of the points below to prevent that from occurring:

1. Do not touch the projection surface with your hands
2. Do not write or draw on the projection surface
3. Do not use fingers or sharp objects to point on the projection surface; this will damage the screen material.
4. Use a soft-damp cloth to clean the projection surface; do not use chemical cleaning agents or alcohol.
5. Use clean water when dampening the cleaning cloth and do not rub against the material to clean it.

◆ To avoid damage and injury, the screen should only be operated by adults.

IP Rating Chart

1st Digit - SOLID

Degree of protection against solid objects



Protected against a solid object greater than 2.5mm, such as a wire.

3

2nd Digit - LIQUID

Degree of protection against water



Protected against water spray at 60 degree angle.

3

Important Safety & Warning Precautions

Make sure to read this user's guide and follow the procedures below.

- Please retain this user's guide for future reference.
- To avoid damaging the unit, do not use with any unauthorized accessories not recommended by the manufacturer.
- Handle the unit carefully during transportation to avoid any damages.
- To ensure safe and reliable operation, direct connection to a properly grounded power source is advised.
- The power outlet supplying power to the unit should be close to the unit and easily accessible.
- Do not install the unit on uneven or inclined surfaces.
- Do not put heavy objects on the power cord and position it properly to avoid creating a trip obstacle.
- Never overload the power cord to prevent an electric shock or fire due to a loose contact or a short circuit.
- There are not user serviceable parts in this unit. Do not attempt to disassemble this unit by yourself. No one except authorized technicians can open and make repairs to this unit.
- Make sure the power source this unit is connected to has a continuous power flow.
- If there is need to use an extension cord, make sure the cord has an equal rating as the appliance to avoid overheat.
- Do not handle the power plug when your hands are wet or your feet are in contact with water.

Do not use this unit under the following circumstances.

- Disconnect the power cord under the conditions of heavy rain, wind, thunder or lightning.
- Avoid direct Sunshine, rain shower and moisture.
- Keep away from fire sources and high temperature to prevent this device from overheating.
- Cut off the power supply first before transportation or maintenance.
- Fully disconnect from the power supply when the unit is not in use for a long period of time, as should be done with any other electric household appliance.
- To avoid possible injury and/or an electric shock, do not attempt to use the screen if there is obvious damage or if there are any evident broken parts.

WARNING

The Screen's **Top Black Drop** is already set to its maximum drop distance. There is **NO** extra top black drop in the roller. Please be aware of this as it will void the limitation of your warranty.

Individual modifications to this product are prohibited and will void the warranty with the manufacturer. Please contact Customer Service for any questions.

NOTE:

This equipment has been tested and found to comply with the limits for a Class B digital device, pursuant to Part 15 of the FCC Rules.

These limits are designed to provide reasonable protection against harmful interference in a residential installation. This equipment generates and can radiate radio frequency energy and, if not installed and used in accordance with the instructions, may cause harmful interference to radio communications.

However, there is no guarantee that the interference will not occur on a installation. If this equipment causes harmful interference to radio or television reception, which can be determined by turning the equipment off and on, the user is encouraged to try to correct the interference by one or more of the following measures.

- ✓ **Reorient or relocate the receiving antenna of the device which may be causing the interference.**
- ✓ **Increase the separation between the screen and the device's receiver.**
- ✓ **Connect the equipment into a different power outlet other than the device.**

Pre-Installation







1. Carefully unpack the screen.
2. Always handle the screen in a leveled position on a clean surface.
3. In order to protect the screen from exposure to stains, keep the screen out of contact with foreign particles such as dust, sawdust, and/or liquids.

NOTE

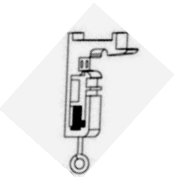
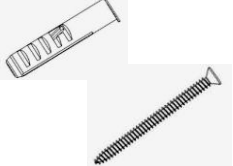
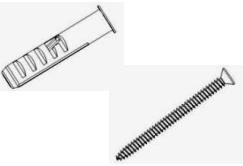
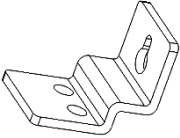
Wall screws included with this product are complimentary and may not be adequate for all mounting surfaces. Consult with a professional installer or hardware store for proper mounting screws and anchors.

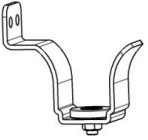
Regardless of the mounting method, the screen should be securely supported so that the vibration or pulling on the viewing surface will not cause the casing to become loose or fall. The installer must ensure that the fasteners used are of adequate strength and suitable for the installation location.

Hardware Parts List for Yard Master Electric Series

A. Mounting Bracket x2pcs	B. M10 Anchor and M4x50 Screwx4pcs	C. M8x35 Anchor and M4x35 Screwx4pcs	D. Suspended Ceiling Bracket Connectorx2pcs	E. M5x15 Screw & Bolt x4pcs
				
G. Magnetic weight bar bracket x2pcs	H. Curved Stake x2pcs	I. Snap linkx2pcs	J. Elastic String x2pcs	K. Bubble levelerx1pc
				

Flush Mount to the Wall

1. Mark the location of where the screen is to be installed, drill your holes and insert the **M10 Anchors (B)**.
2. Install the **Mounting Brackets (A)** to the wall and secure with the **M4x50 Screws (B)**.

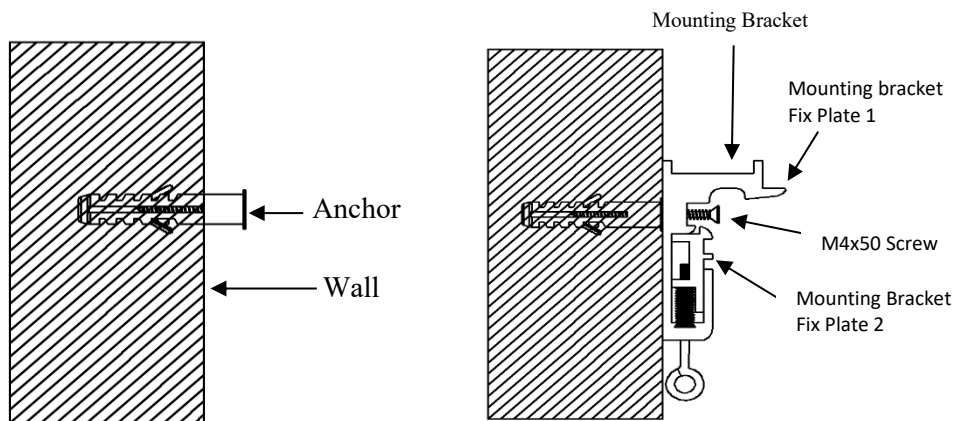

3. Attach the screen to the **Mounting Brackets (A)** by inserting the top of the case to Fix Plate 1 and securing the back of the case to Fix Plate 2. Make sure the case slots are securely attached to the mounting brackets.

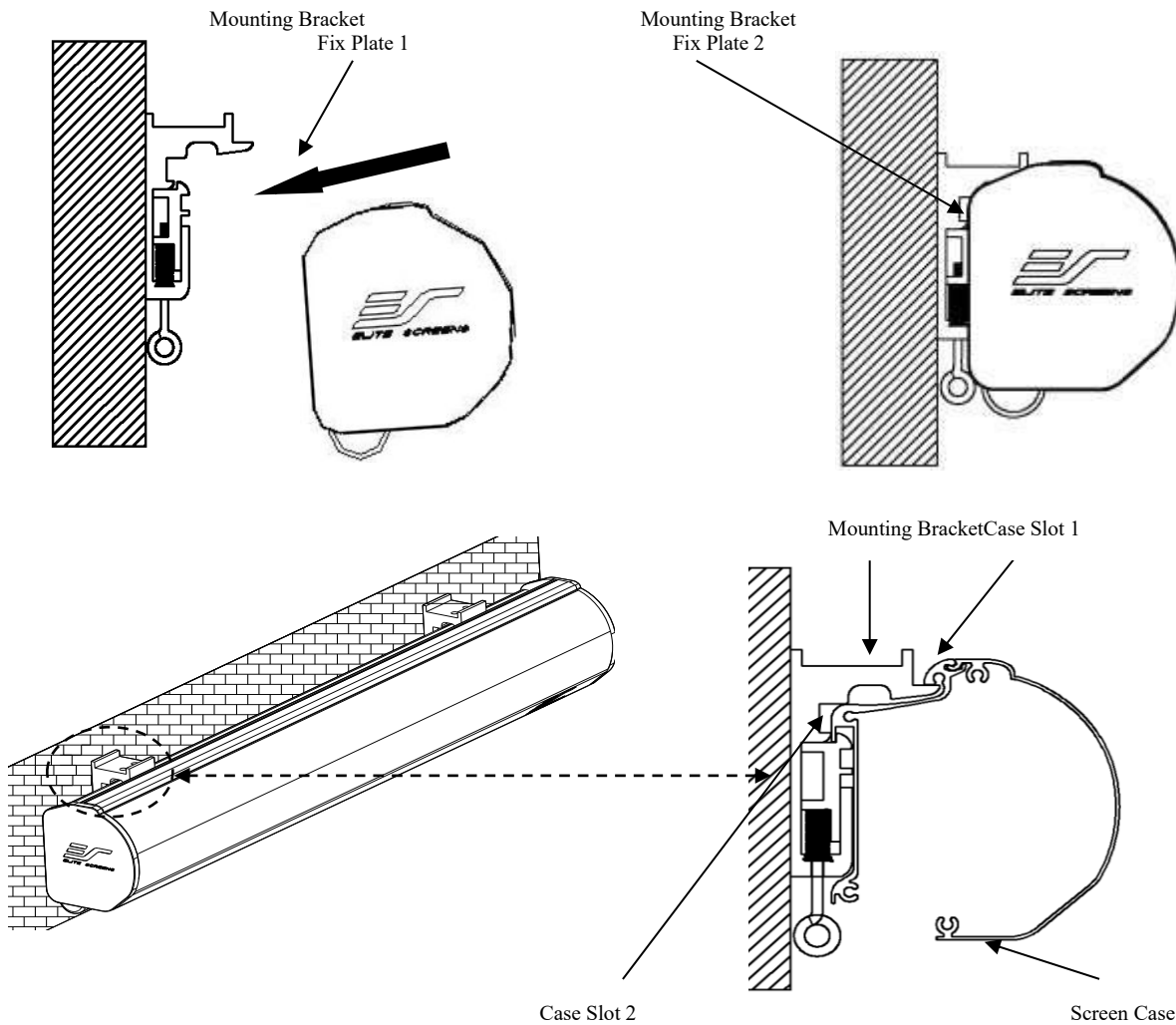

Flush Mount to the Ceiling

Note: Please make sure the Mounting Bracket (A) is close to the wall when you install the screen on the ceiling. This is to ensure the weight bar aligns with the magnetic bottom bracket when it comes down.

1. Mark the location of where the screen is to be installed, drill your holes, and insert the **M10 Anchors (B)**.
2. Install the **Mounting Brackets (A)** to the ceiling and secure with the **M4x50 Screws (B)**.

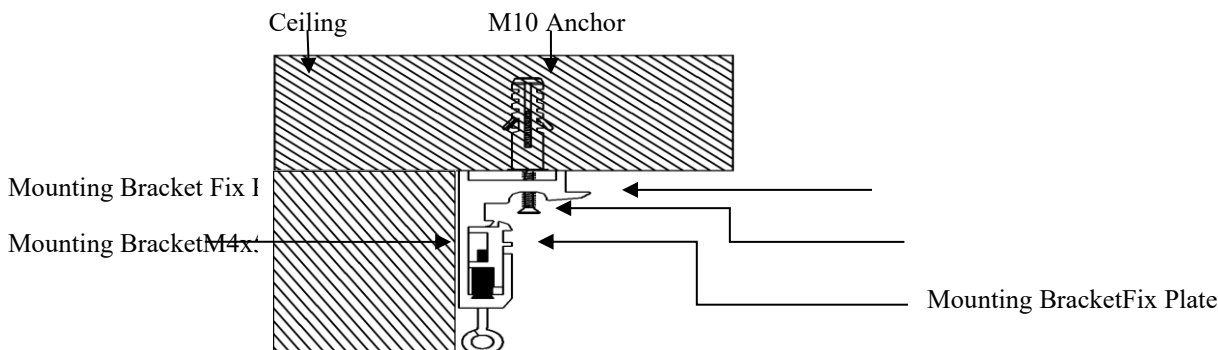

3. Attach the screen to the **Mounting Bracket (A)** by inserting the top of the case to **Fix Plate 1** and securing the back of the case to **Fix Plate 2**. Make sure the case slots are securely attached to the **Mounting Bracket (A)**.

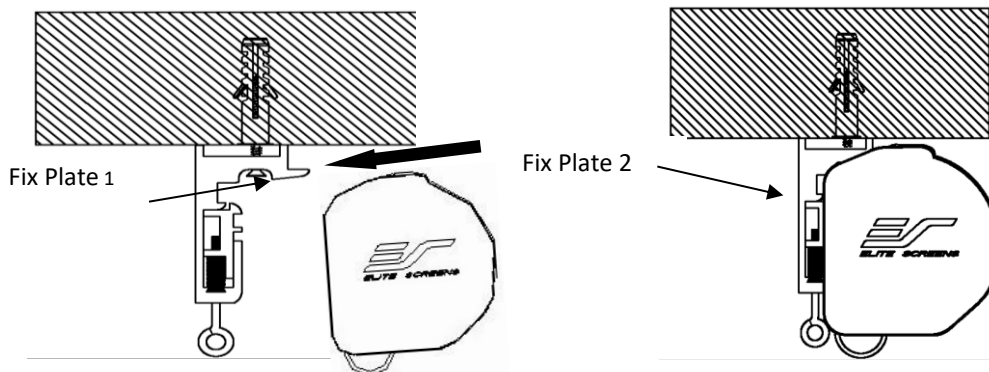

Suspended Ceiling using Chains (additional hardware required)

1. You can also hang the screen on a ceiling by using chains (not included).
2. Connect the **Suspended Ceiling Bracket Connector (D)** to the **Mounting Bracket (A)** and secure with the **M5x15 Screws & Bolts (E)**.

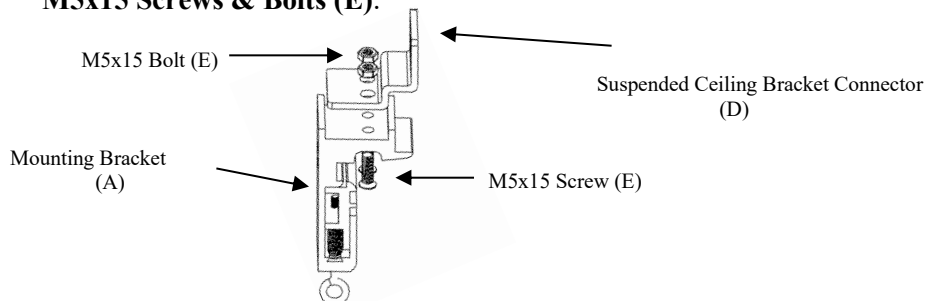

3. Insert chains (not included) through the loop holes of the **Suspended Ceiling Bracket Connector (D)**.

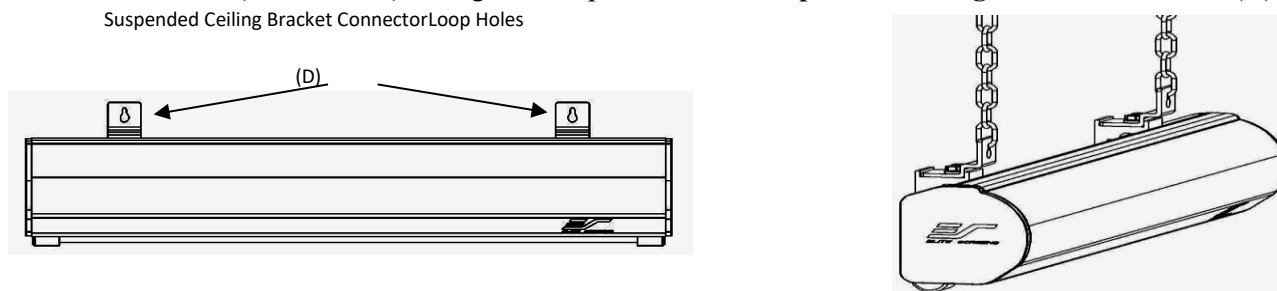

Screen removal from the Mounting Brackets

1. Pull down on the **Mounting Bracket Release Tab** and remove the bottom case away from the wall/ceiling followed by the top of the case.

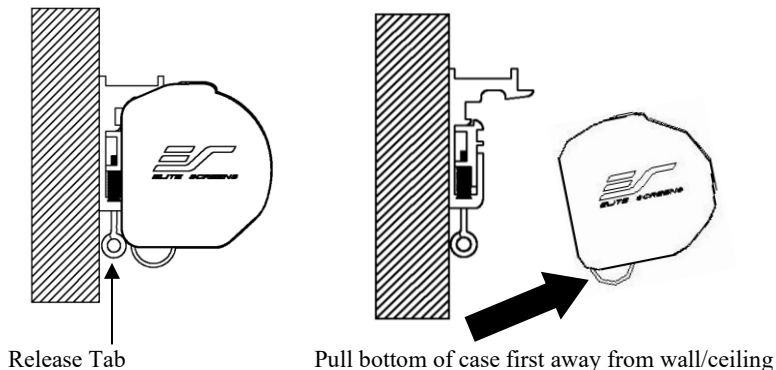

Yard Master Electric Control System and Operation

Yard Master Electric Series Controls

A. RF Remote Control x1pc (Battery built-in)

B. Wireless trigger (USB type) x1pcs

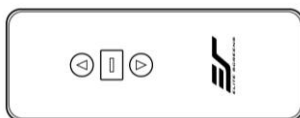

Screen operation

Electric Current: Depending upon region, your Elite Screen will operation 110v or 220v voltage.

1. After ensuring the power outlet & screen are compatible (voltage), plug the power cord into the power outlet.
2. Once the screen has power, you'll be able to control it using any of the **2 methods** described below.

2 ways to control your Yard Master Electric Screen

1. RF Remote Control (Item A): The radio waves eliminate the need for a direct line of sight and has a range of 100 feet.

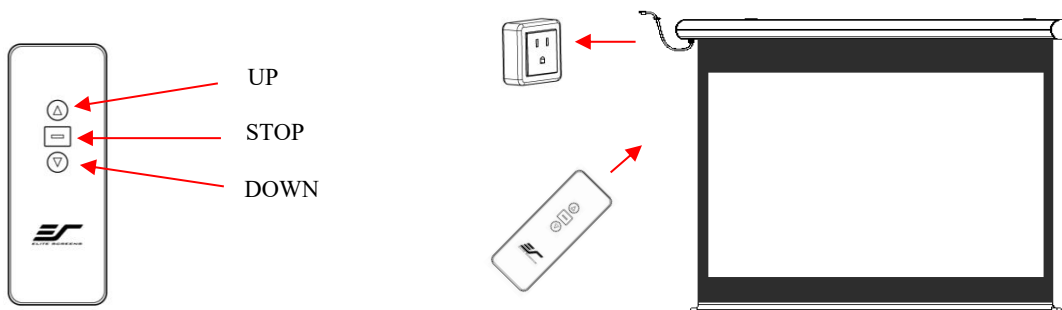

Radio Frequency (RF) Remote Synchronization Instructions

1. Unplug the screen's power cable from the power outlet.
2. Press and HOLD the UP button on the RF remote (See diagram above)
3. While holding the UP button, plug the screen's power cable back into the power outlet.
 - a. You should hear a single "beep" when the power cable has been plugged in, indicating it has entered pairing mode.
4. After hearing a set of multiple "beeps", release UP button for 2seconds, then press UP button again.
5. You should now be able to control your electric screen with the RF remote control.
6. If unsuccessful repeat from Step 1.

Note: The beep(s) the screen produces are very faint. It may be difficult to hear, if more than 5 feet away from the screen.

2. Wireless trigger (USB type) (Item B): The wireless trigger allows your screen to synchronize its drop / rise operation with the projector's power cycle.

- a. **Plug** the wireless trigger into the USB port of the projector.
- b. **Power ON** the projector. The screen should drop (down) automatically.
- c. **Power OFF** the projector. The screen should retract (up) automatically.

Wireless Trigger Set Up Instructions

Code learning (pairing):

1. Plug the wireless trigger into the projector's USB port.
2. Press the "**Stop**" button on the remote control that has already been successfully paired for 5 seconds.
3. The screen will move up and down once indicating it has entered the code-pairing state.
4. Briefly press the "Set" button on the USB trigger, at this point, the screen will move up and down, indicating successful code learning.
5. **Power ON** the projector. The screen should drop (down) automatically.
6. **Power OFF** the projector. The screen should retract (up) automatically.
7. If unsuccessful repeat from Step 1.

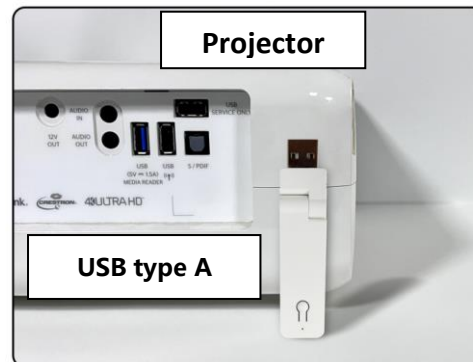
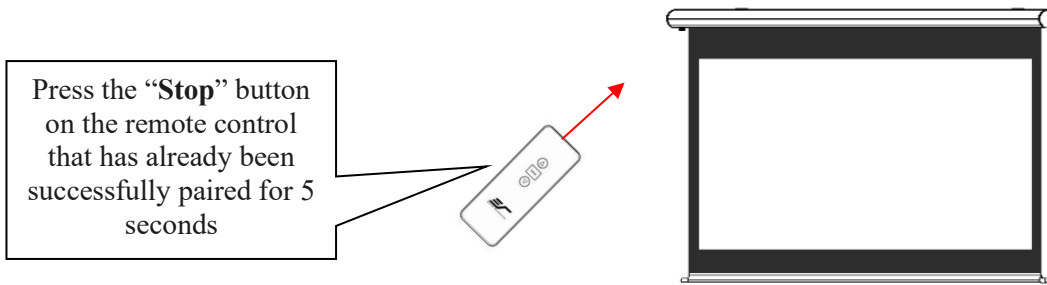

Magnetic bottom bracket Installation

1. After the screen is plugged in to a power outlet, press the DOWN button on the RF remote control(F). Install the magnetic bottom bracket (G) so that the weight bar sleeve cradles inside (see picture below).

Note: The screen should deploy straight down and align with the magnetic bottom bracket (G). Once the weight bar is cradled inside the magnetic bracket, the screen will be from movement.

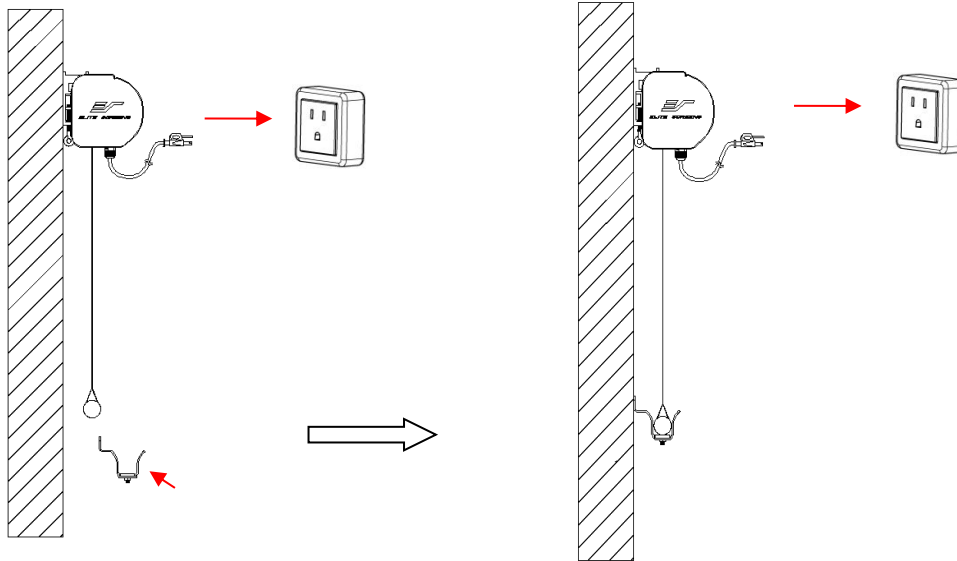

2. Mark the drill-hole area of where the bracket is to be installed with a Marker or Pencil.

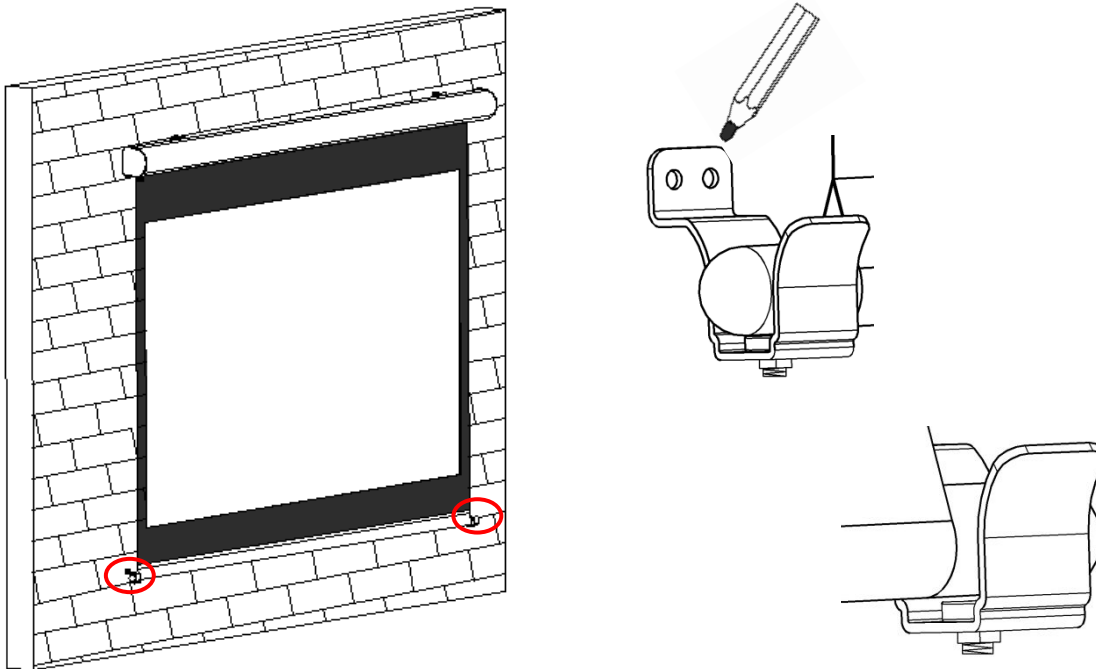

3. Raise the screen UP using the RF remote control. Next, drill holes to insert the M8 x35 Anchor (C) if installing to a dry wall. Then affix the magnetic bottom bracket (G) on the marked location and secure it with an M4x35 Screw(C).

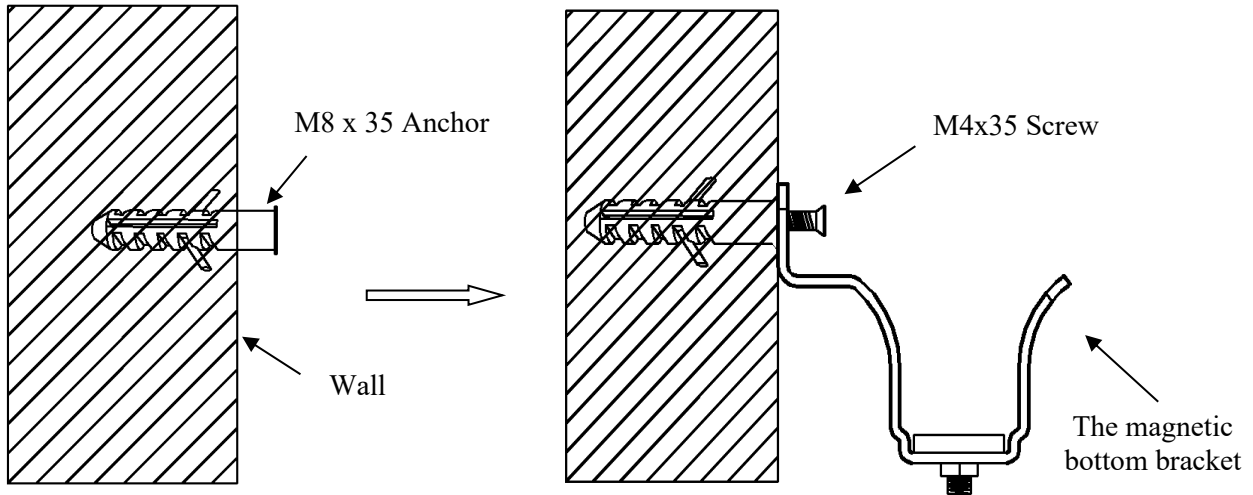

4. Drop the screen DOWN using the RF remote, see if the position of the magnetic bottom bracket (G) is correct or not. Reposition the magnetic bottom bracket if needed.

How to ground the screen

1. Attach the Hook(I) into the Iron Ring, and join the **Hook(I)** and **Curved Stake (H)** using the **Elastic String (J)**,
2. Drive the **Curved Stake(H)** to the ground and stretch the **Elastic String (J)** in the direction of the Curved Nail(H) to secure screen to the ground and supply adequate tension to the screen.

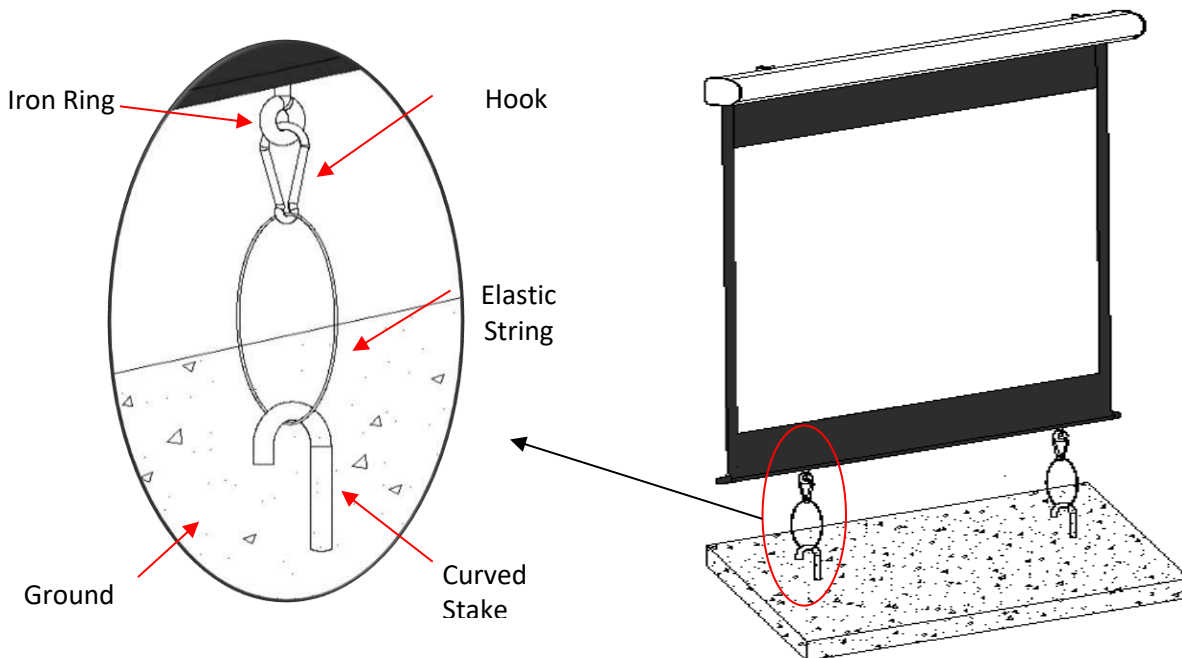

For more information, technical support or your local EliteScreens contact, please visit www.elitescreens.com / www.elitescreens.eu