



Kestrel Tab-Tension 3 | CineGrey 4D

*Floor Rising Ceiling Ambient Light Rejecting
Portable Electric Screen*

User's Guide – J Type **For 133" and 150" models**

The **CineGrey 4D (Ceiling Ambient Light Rejecting)** is best for family rooms, educational facilities, conference rooms or any applications in which incident light is a factor for use with standard throw projectors (long-throw).

In order for the **projection screen material** to maintain its projection qualities and optimum performance, please refer to the list below for proper maintenance and cleaning.

- Use a dry microfiber cloth to remove dust from the screen's surface.
- When cleaning, use a damp microfiber cloth with warm water to remove any marks.
- Never rub or apply pressure when cleaning the surface.
- Never attempt to use any solutions, chemicals or abrasive cleaners on the screen surface.
- In order to avoid damaging the screen, avoid touching it directly with your fingers, pens/pencils or any other sharp or abrasive objects.

Screen Identification

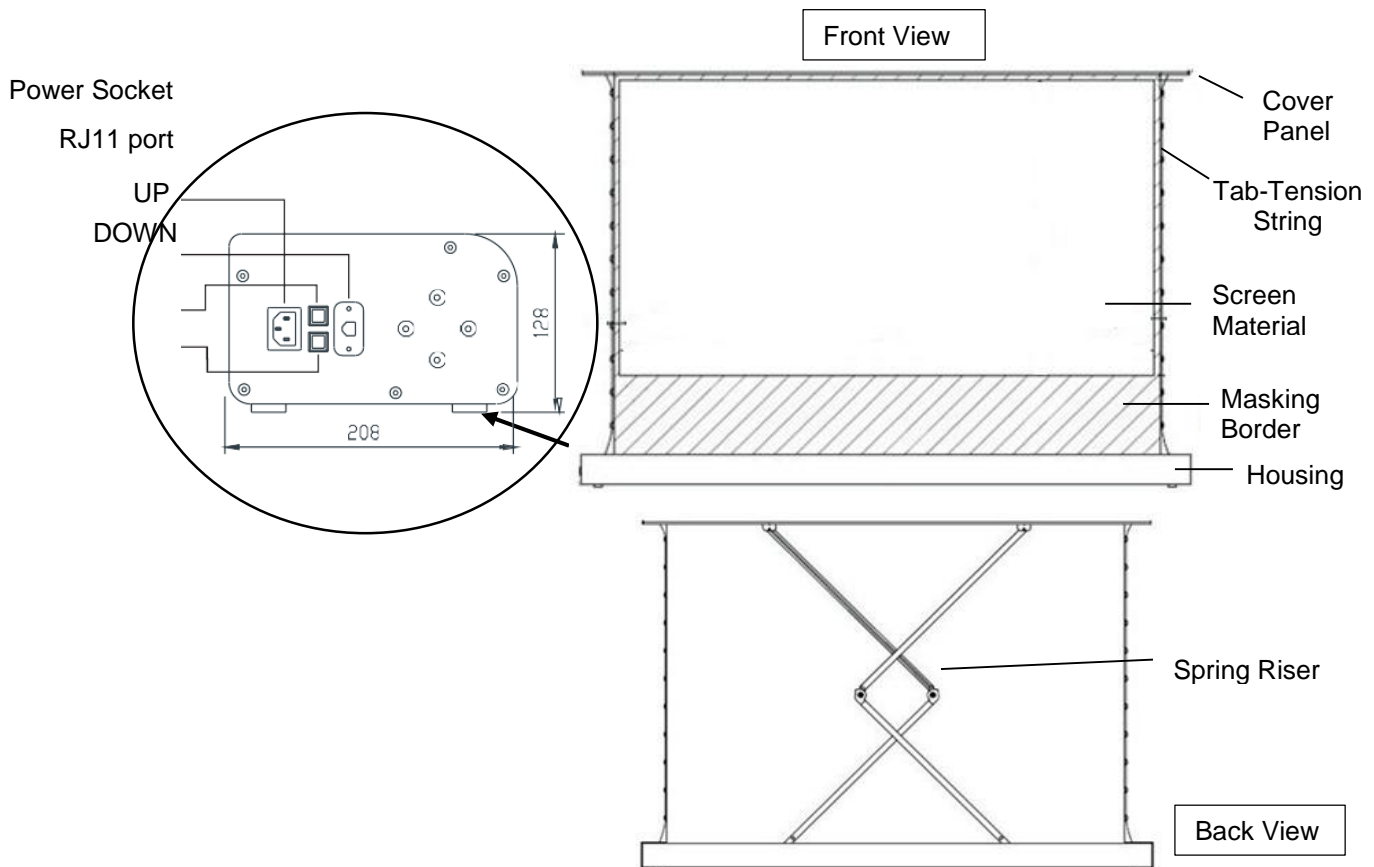

IMPORTANT SAFETY NOTES

Caution: The screen's Black Bottom border is already set to its maximum distance. There is NO extra Black Bottom in the roller. Unapproved changes or modifications to this unit are prohibited and will void your warranty. For more information, please contact our Technical Support Department at 562-483-8198.

1. Please read this manual before use and follow the procedures specified:
 - a) Please retain this manual for future reference.
 - b) To avoid any damages to the screen, do not use any accessories or parts not recommended by Elite Screens.
 - c) Handle the device carefully during transportation.
 - d) Do not set up screen on uneven surfaces.
 - e) To prevent electrical shock or fire; never overload the power cord and avoid contacting the motorized components with liquids or foreign objects.
2. **The tubular motor equipped in the screen feature an overheat protection sensor. If the screen is consecutively brought up and down between 3-4 minutes, the motor will automatically shut-off to prevent the motor from sustaining damage through overheating. If the automatic shutoff is activated, please allow 30 minutes cool down before resuming operation.**
3. The screen is equipped with a strong tension cross-spring system. **DO NOT** attempt any unnecessary repairs.
4. When using the screen, please
 - a) Avoid strong wind, rain, or electrical storms.
 - b) No direct sunshine (UV Radiation) or moisture.
 - c) Keep away from fire sources and high temperature devices.
 - d) Turn the power off before moving this product.

NOTE:

- This equipment has been tested and found to comply with the limits for a **Class B** digital device pursuant to Part 15 of the FCC Guidelines.
- The products are designed to provide reasonable protection against harmful interference in a residential/commercial installation and end user application and may radiate radio frequency energy.
- However, there is no guarantee that interference will not occur in a particular installation. If this equipment does cause harmful interference to radio or television reception, which can be determined by turning the equipment off and on, the user is encouraged to try to correct the interference by one or more of the following measures:
 1. The power outlet should be close to the unit and easily accessible.
 2. Re-orient or relocate the receiving antenna.
 3. Increase the separation between the equipment and the receiver.
 4. Connect the equipment into an outlet on a circuit different from that to which the receiver is connected.

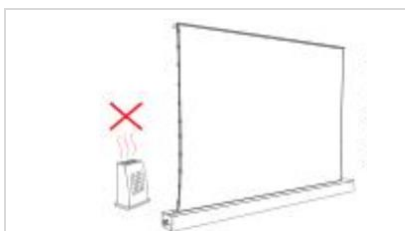

Do not place the screen near a fireplace or high temperature objects such as gas stove, barbecue, or heater



Keep away from children!



Keep hands clear from the closing panels!

Notice to Installer:

Please use the following installation instructions to obtain superior optical performance from the CineGrey 4D Angular Reflective ALR (Ambient Light Rejecting) Screen.

- Angular-Reflective material is not compatible with ultra, or short-throw projectors
- Minimum lens throw ratio 1.5x image width
- Ambient light must not come from the same direction as the projector

Since angular-reflective means that the projected image will reflect at the mirror-opposite angle, it is important to position the projector so that the viewer will get the best possible image.

Step 1: Establish the general “eye level” of the viewers

Step 2: Set the appropriate projection level

Step 3: Adjust the screen height level and projection angle

Input Angle (A) = Output Angle (B) aligns with the viewer’s angle

Correct Installation Examples

Projector Ceiling Installation: Make sure the projector (*light in*) is angled (A) to reflect (B) at the mirror-opposite angle (*light out*) to align with the viewer’s eye level.

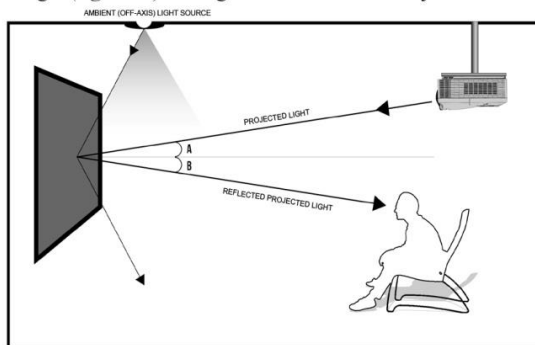

PROJECTOR CEILING INSTALLATION

Projector Table Top: Make sure the projector (*light in*) is angled (A) to reflect (B) at the mirror-opposite angle (*light out*) to align with the viewer’s eye level.

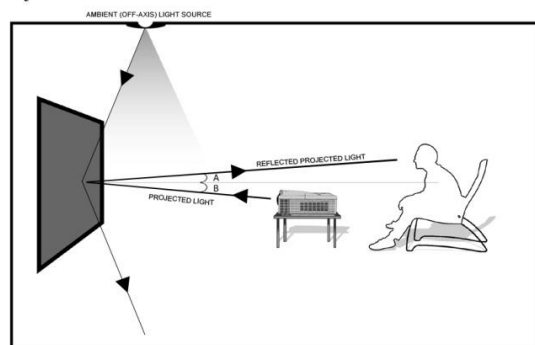

PROJECTOR TABLE TOP INSTALLATION

Incorrect Installation Examples

Ceiling Mounted Short-throw Projector

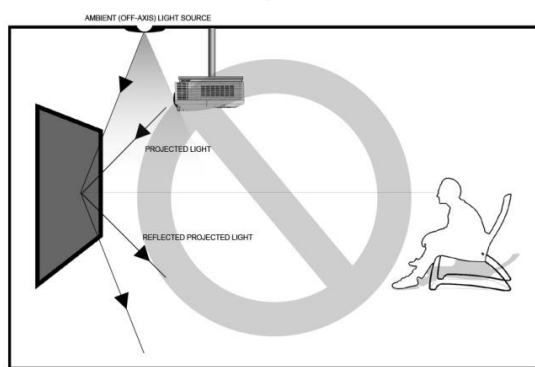

CLOSE UP CEILING PROJECTOR ILLUSTRATION (NOT COMPATIBLE)

Tabletop Ultra-Short throw Projector

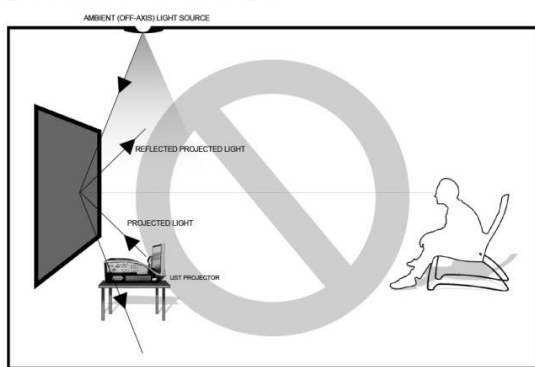

ULTRA SHORT THROW PROJECTOR ILLUSTRATION (NOT COMPATIBLE)

Note: Improper installation will result in light loss and produce a dark image. This is due to the projector’s light reflecting in the wrong direction.

Images are not up to scale and are for illustration purposes only.

Screen Setup

IMPORTANT: The screen must be placed in horizontal position on a level ground.

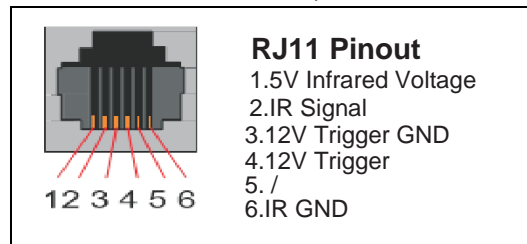
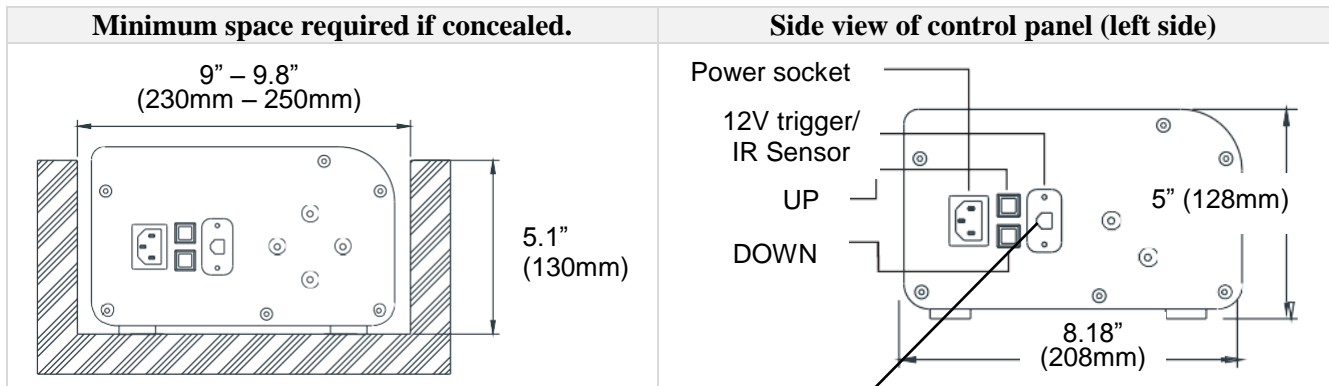
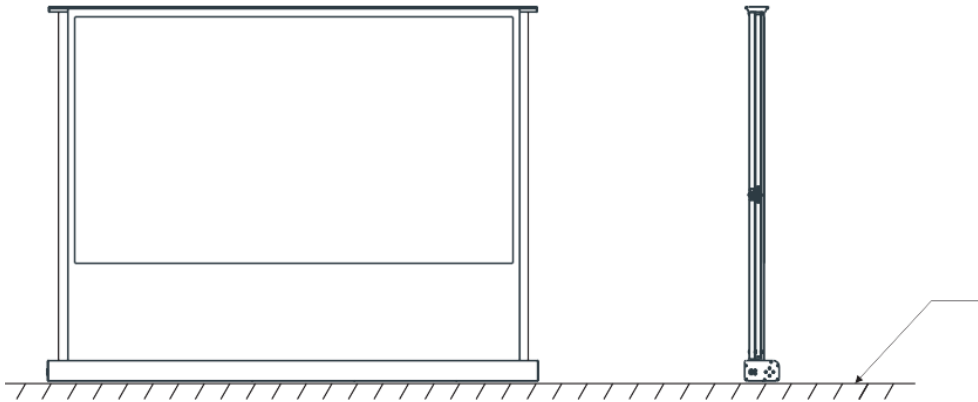

Kestrel Tab-Tension Controls and Accessories

A. IR Remote	B. RF Remote	C. IR "eye" Sensor	D. 12 v trigger cable
		<p>Length 78.7" (2 m)</p>	<p>Length 11.8" (30 cm)</p>

Screen Operation

Electric current: The screen operates on AC 110V at 60hz (US/Canada/Mexico only)

- Plug the screen into a power outlet and control the screen using the included remote controls.
- Once the screen has power, you will be able to control it using any of the 3 methods below.

Three ways to control the Kestrel Tab-Tension Screen

1. **IR Remote control:** The IR (Infrared) remote requires line-of-sight to the IR sensor. Plug the IR sensor into the RJ11 port on the left side of the screen's case. Point the IR remote directly at the IR sensor to control the screen.

- Note:**
- a. The IR remote has a range of 15 ft.
 - b. The IR sensor must not be covered or blocked.
 - c. If IR sensor is plugged in then 12v cable cannot be used. Only one or the other can be used at a time.

2. **RF Remote control:** The RF remote does not require line-of-sight and can be used to control the screen from anywhere up to 50 ft.

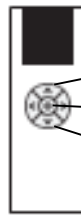

- UP Press the **UP** button to Raise the screen
- STOP Press the **STOP** button to stop the screen
- DOWN Press the **DOWN** button to Retract the screen

3. **12 v trigger:** The built-in 12V trigger input allows your screen to synchronize its rise & drop with the projector's power cycle. The screen rises when the projector powers up and will retract when the projector powers down. The 12-volt RJ11 cable connects to your projector's trigger output via a separate cable such as a 3.5 mm mono that may or may not be provided by the manufacturer of the projector. The trigger feature will not work without an output cable from the projector, but it can be tested by connecting the Red (+) and Green (-) cable to a 9-volt battery. A 3.5mm mono jack cable is needed to splice together with the 12v trigger cable for this feature to work.

Note: Not all projectors have a trigger output port for this feature.

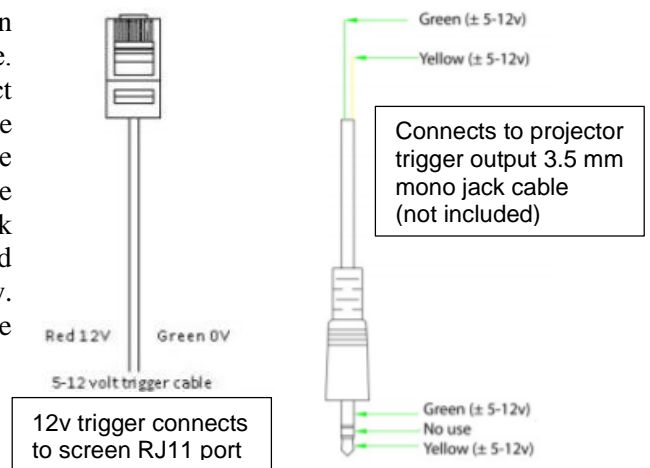

Storing the screen: Always store the screen flat horizontally. Never store the screen in a vertical position.

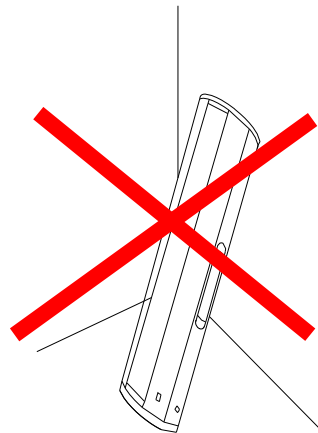

For Technical Support or an Elite Screens contact in your area, visit www.elitescreens.com