



YardMaster 2 WraithVeil® DualSeries

(150" and Above) Indoor/Outdoor Portable Projection Screen

User's Guide – Z type

Thank you for choosing the *Yard Master WraithVeil® Dual* portable projection screen! Please read through this user guide before utilizing the screen. Correct usage and maintenance will ensure a long product life.

Care & Use Instructions

- ◆ Elite Screens highly recommends two people to assemble the *Yard Master 2 WraithVeil® Dual* screen.
- ◆ The *WraithVeil® Dual* is a 2-directional flexible vinyl projection screen material. It is designed to accommodate either front or rear projection.
- ◆ Be sure to use the screen only during a light breeze (up to 7 mph); it is not meant to withstand heavy winds. **Elite Screens is not responsible for damages due to negligence resulting from misuse under weather conditions and will void your warranty.*
- ◆ Dust, dirt and scratches on the projection surface will affect the picture quality, please take note of the points below to prevent that from occurring:
 1. Do not touch the projection surface with your hands
 2. Do not write or draw on the projection surface
 3. Do not use fingers or sharp objects to point on the projection surface; this will damage the screen material.
 4. Use a soft-damp cloth to clean the projection surface; do not use chemical cleaning agents or alcohol.
 5. Use clean water when dampening the cleaning cloth and do not rub against the material to clean it.
- ◆ After using the screen, disassemble it and store it in the carrying bag provided.
- ◆ To avoid damage and injury, the screen should only be operated by adults.

Product Description

Design: The aluminum frame is designed to be light weight and easily operated making it easy to carry, assemble and disassemble.

Screen Fabric: The screen fabric is attached to the rectangular frame and held in place by several press stubs, which ensure an evenly stretched and flat surface. The *WraithVeil® Dual* (front/rear projection) screen material is durable and can be folded many times without causing damage or distortion to the surface.







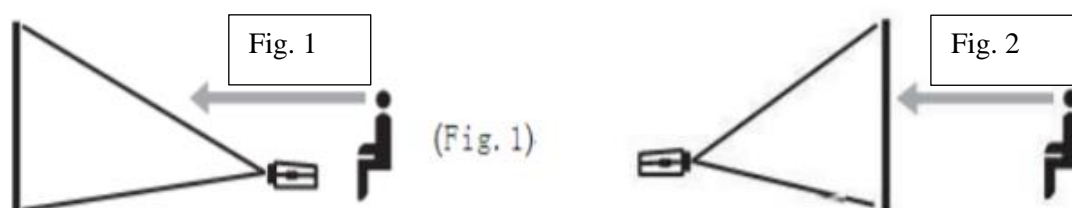

Correct usage of the projection screen will ensure better viewing results.

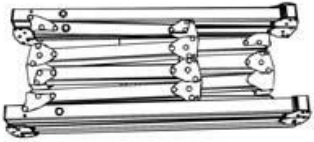
For front projection, assemble and view the screen as indicated in Fig. 1.

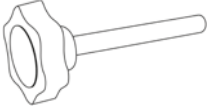
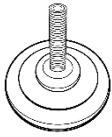
For rear projection, assemble and view the screen as indicated in Fig. 2.

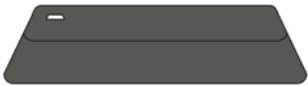

Hardware and Parts List

<p>A. Folding frame x1</p> 	<p>B. Left/Right folding legs x2 (Adjustable)</p> 	<p>C. Center brace x1 (Adjustable)</p> 
<p>D. Knob Screw (Refer to Chart)</p> 	<p>E. Center brace foot (Refer to Chart)</p> 	<p>F. Projection screen material x1</p> 
<p>G. Screen material bag x1</p> 	<p>H. Carrying Bag x1</p> 	<p>I. Rope</p> 
<p>J. Eyebolt x 2</p> 	<p>K. Ground stake x 4</p> 	

Note: The parts list above is subject to change without notice.

Models	Knob Screw	Center Brace Stand	Max Height
180" (16:9)	12 pcs	1 pc	163.3 inches

Frame Assembly

1. Take the *folding frame (A)* out of the *carrying bag (H)* and place it on a flat surface. Fully unfold the longer sections first, as shown below.

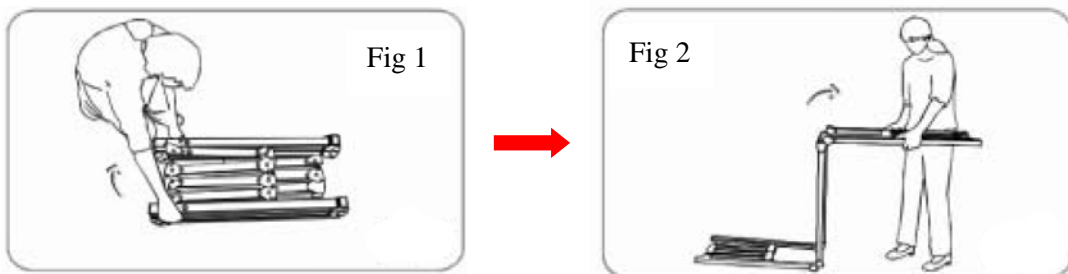

2. Next, unfold the frame until the latch on the hinge "clicks" into place. Repeat the procedure for the shorter sections, as shown below.

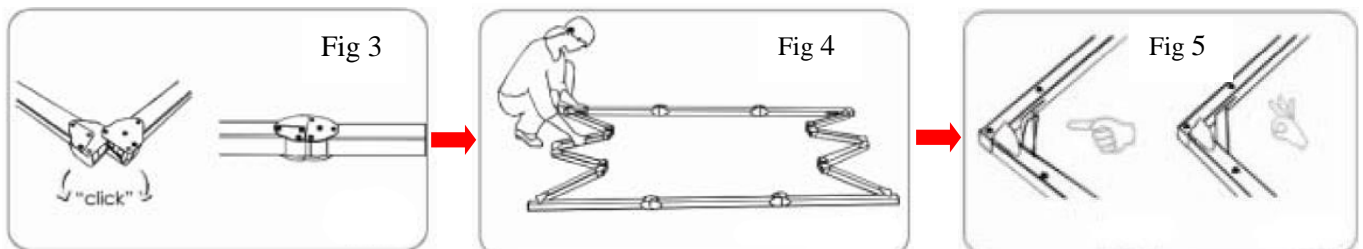

Note: When unfolding the frame and legs, be sure the latches on the hinges "click" into place. Please also make sure all 4 corners of the frame are at a 90° angle and the hinged support bar is straight and not bent.

3. Next, screw the **eyebolts (J)** into the openings located at the top of the frame.

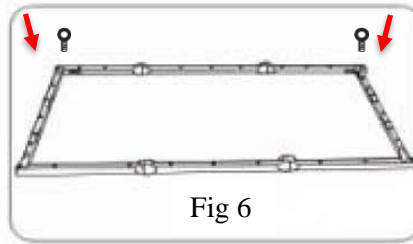

Screen Material Attachment

1. Take the **screen material (F)** out of the **screen material bag (G)** and align the corners of the screen material with the inside corners of the frame.

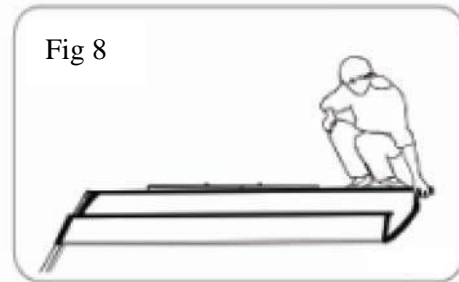
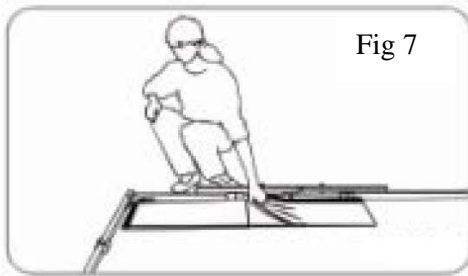

2. Once the screen material is fully extended, secure the material by snapping the buttons onto the frame studs. Fasten the buttons in the following order as shown on **Fig. 9**.

Note: Snap the buttons on each corner first, then work your way out to the center on each side.

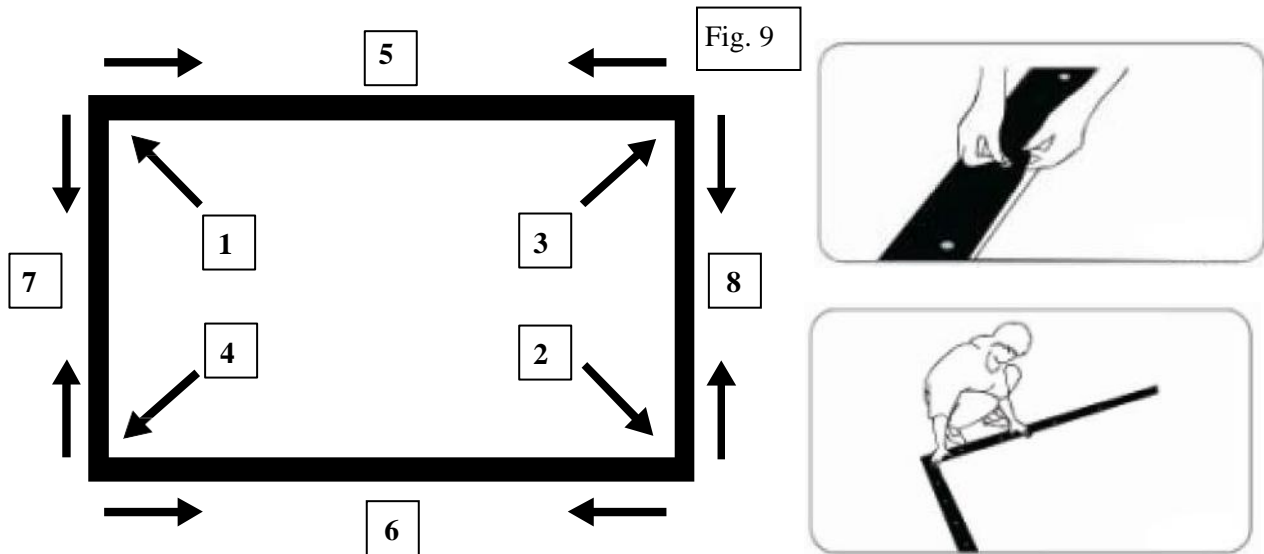

Leg Attachment and Height Adjustable feature

1. Carefully take the **left and right folding legs (B)** out of the **carrying bag (H)** and place them on a flat surface. Unfold the leg(s) and make sure the hinges click into place. Use the **knobscrews (D)** to attach the frame to the legs at the desired location for your height requirement per the instructions below.



2. Lay the frame on its backside on clean surface, then lay the legs over on the frame in the position desired.

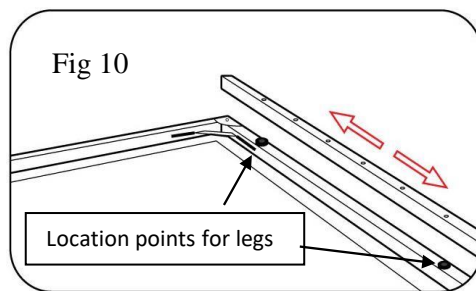

3. Once you have aligned the leg's holes with the frame's holes, secure with the knob screws.

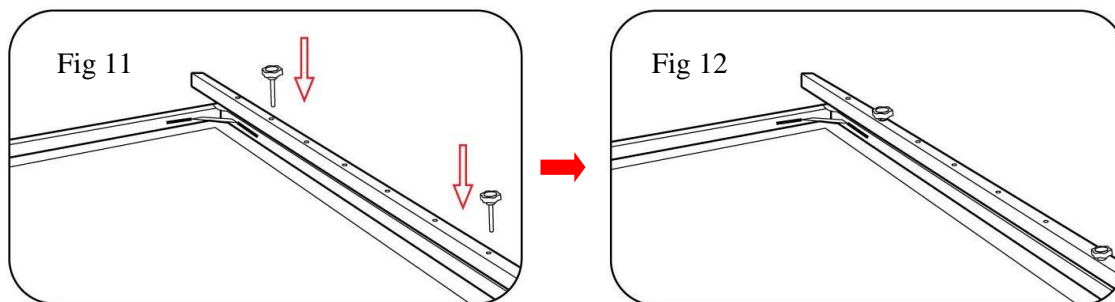

Warning: When attaching the legs, make sure to screw the top of the leg to the last hole of the frame to reach max height. Attaching the legs lower to the frame and leaving an extra space on top may cause the screen to tip over when assembled.

4. Tie 4 pieces of *rope* (2 on the left and 2 on the right) to the *eyebolts (J)* that are located at the top of the frame.

5. Next, lift the screen up while simultaneously opening the legs. Two people are needed for this step. Fig. 13-14.

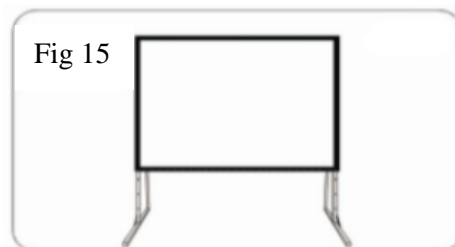
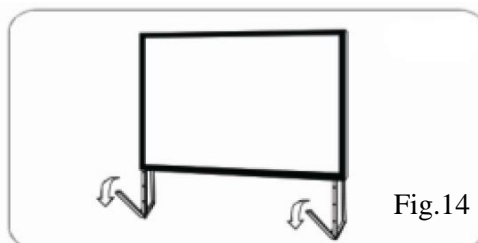
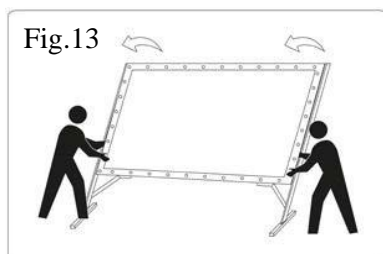

6. Next, carefully unfold the back brace behind the leg and attach it using a *knob screw (D)*. Fig. 16-17.

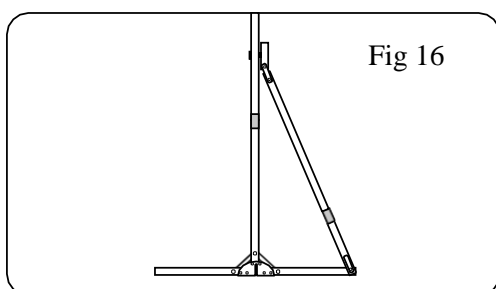

Center Brace, Stake and Ropes

1. Unfold the *center brace* (C), fold the small end as illustrated (Fig. 18), align it to the bottom of the frame's screw hole and then secure it using a *knob screw* (D). Next, attach another *center brace* (depending on the height) using a *knob screw* as shown in Fig 19. Then attach the *center brace foot* (E) to the bottom of the *center brace* (C).

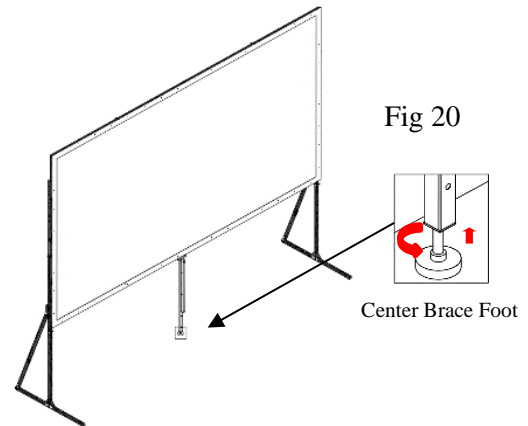
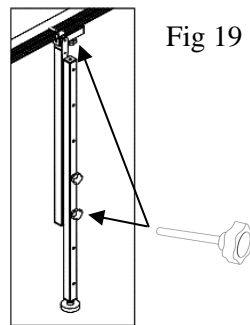
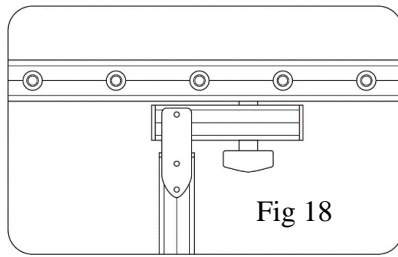

2. To secure the frame, place a *stake* (K) into each hole located on the frame footing, and hammer it into the ground. Finally, tie the 4 *ropes* (I) to the stakes and through the *eyebolts* (J) to prevent the screen from tilting or falling over. As shown in Fig. 21

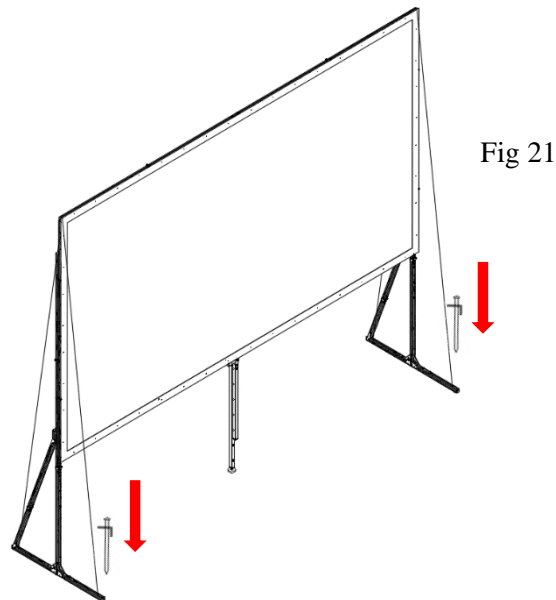

Screen Disassembly

1. After using the screen, disassemble and store it in the *carrying bag* (H). To disassemble the screen, follow the assembly procedure in reverse order.
2. Store the screen in the provided *carrying bag* (H). Be sure to place folding frame, legs, and smaller parts into the carrying bag first and place the material on top to keep material from creasing or tearing.

For more information, technical support or your local Elite Screens contact, please visit www.elitescreens.com