



# ***Yard Master Series***

## Rear Projection Outdoor Movie Screen

### User's Guide (v. 2)







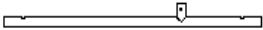

**Note:**

1. The Ring-Stakes, Curved-Stakes & Guy Rope should always be installed for Stability.
2. Use of this product is not recommended in gusty winds over 20mph.

**Maintenance:**

1. Soft cloth with mild soap & water may be used to clean the screen's surface.
2. To prolong the lifespan of this product, store it in its carry case when not in use.

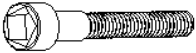
**Parts checklist (Model: OMS103HR/OMS123HR)**

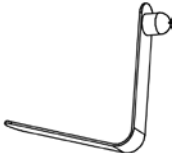
|  |  |  |
|--|--|--|
| <p><b>A. Screen material x1</b></p>   | <p><b>B. Steel tube x12-14</b></p>  | <p><b>C. Fiber glass pole x4</b></p>           |
| <p><b>D. Carrying bag x1</b></p>    | <p><b>E. Guy-ropes x4</b></p>       | <p><b>F. M6hex nuts x2</b></p>                |
| <p><b>G. Curved stake x4</b></p>    | <p><b>H. Ring stake x4</b></p>      | <p><b>I. M6x43mm hex screw x2</b></p>         |
| <p><b>J. Velcro band x24</b></p> <div style="border: 1px solid black; padding: 5px; display: inline-block;"> <p>14 Top/Bottom sections - 15cm bands<br/>10 Left/Right sections - 13cm bands</p> </div>  |  | <p><b>K. Lock Pins (Spare parts) x 5</b></p>  |

**A. Main Support Metal Frame Assembly**

1. Assemble the steel tube frame by connecting the letters on the ends of the tubes together as shown in the picture. *For example, A to A, B to B etc.*

2. *A* and *J* are attached and secured with the provided Hexagonal Screws (*G*). This will be the last step.

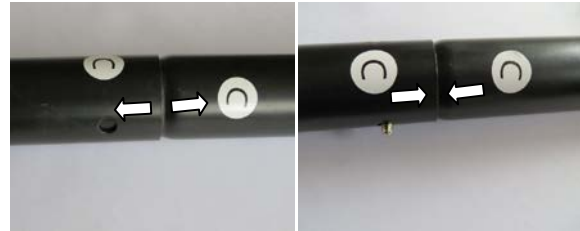
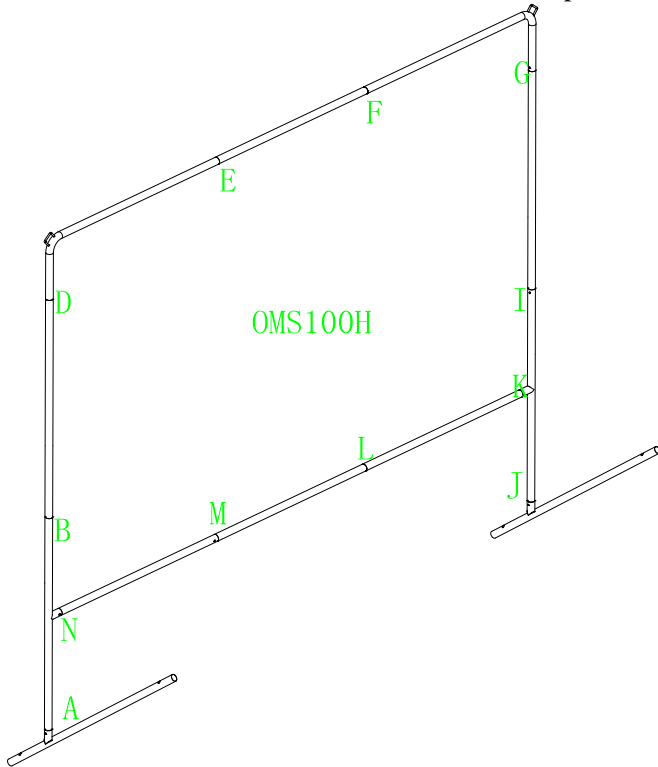

3. After the frame has been built, lay it on a clean scratch-free area.

### **Step 2: Screen Material Frame Assembly (Fiber glass poles)**

1. Join the Fiber Glass Pole to form a straight support rod as shown in the diagram below.

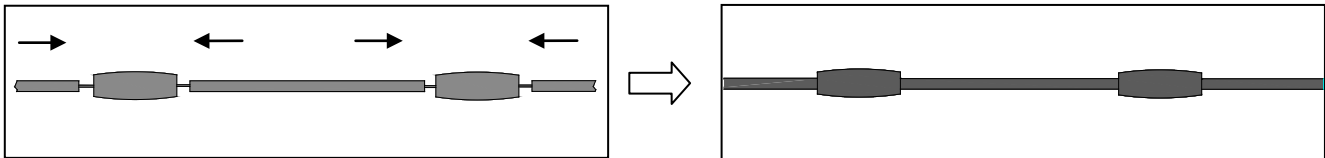

2. Repeat to complete the two horizontal rods. Keep the two vertical rods disconnected for the next steps.

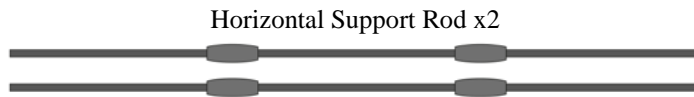

### **Step 3: Attaching the screen material to the frame**

1. Lay out the material on a clean, scratch-free area.

2. Insert the horizontal support rods into the top and bottom sleeves of the screen material.



3. To insert the vertical support rods, fold the material in half (long ways) at the middle opening. Insert both ends of the rod into each half of the material as shown in Fig.1.

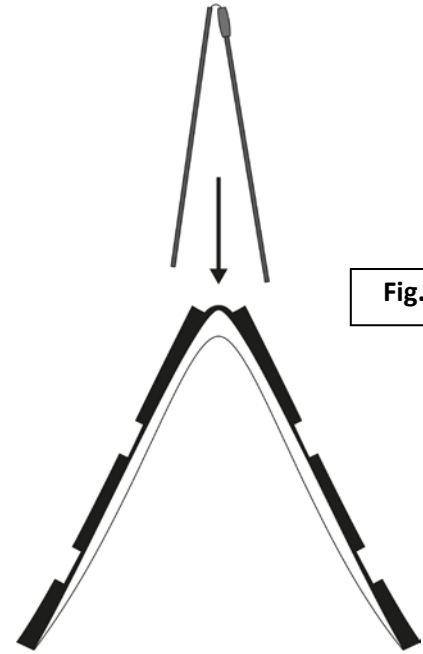
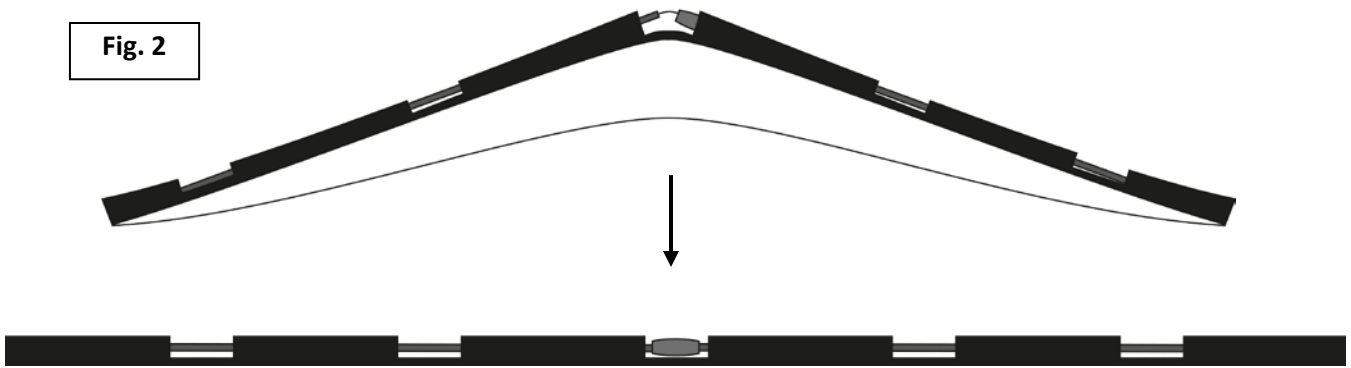

Fig. 1

While folded in half, match the connecting ends of the rod and slowly lower and flatten the material to have the rod connect. (Shown below in Fig. 2)

Repeat for other side.

Fig. 2



4. Keeping the frame laid flat, place and center the screen material (Elite Screens logo facing up) inside the metal frame.

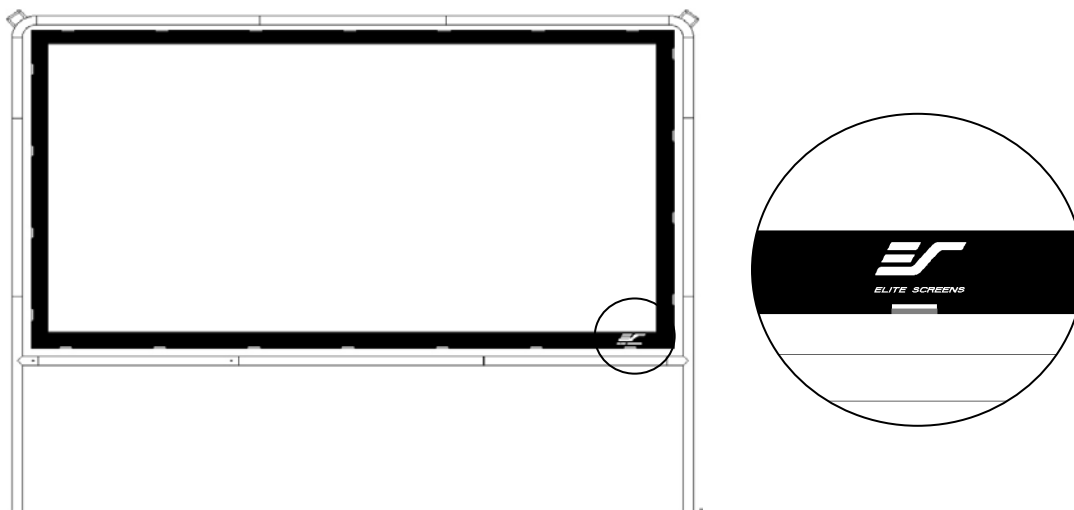

5. Attach the screen material by the exposed areas of the vertical and horizontal support rods onto the metal frame wrapping the velcro bands around the rod and frame. **Two people are recommended for the following steps.**

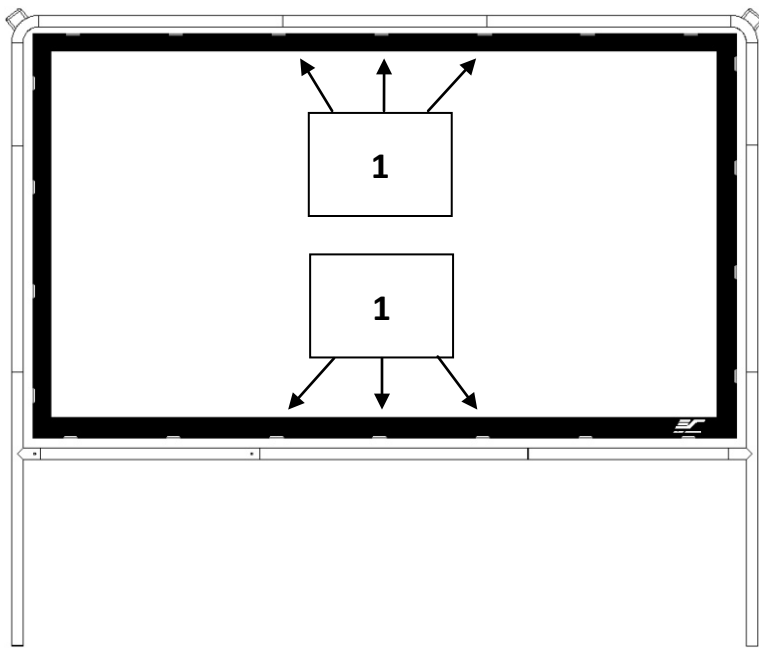

1. With one person at the top of the frame and the other at the bottom, begin by attaching the material with the *velcro bands*, starting at the 3 middle sections keeping the material centered and evenly tensioned.

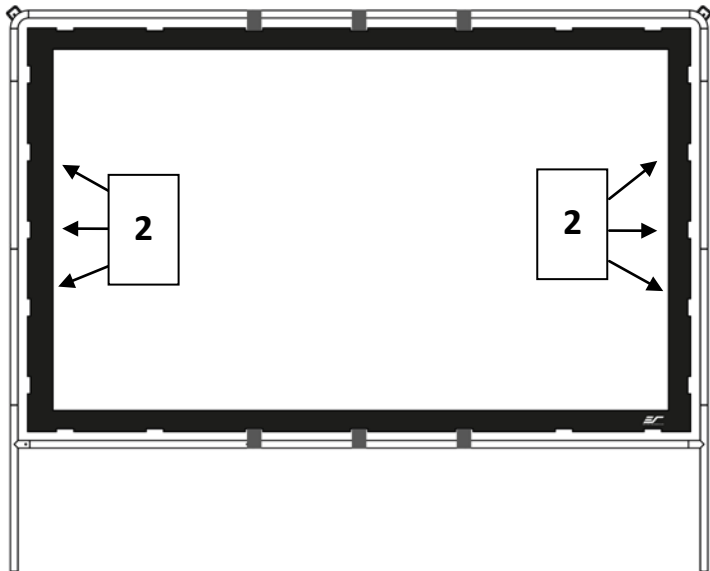

2. Next, with one person at each side, attach the left and right sides of the material with the *velcro bands*, starting with the 3 middle sections.

Note:  
Attach the bands on the *left and right* sides as tightly as possible. This will provide the tension required to make the screen material flat.

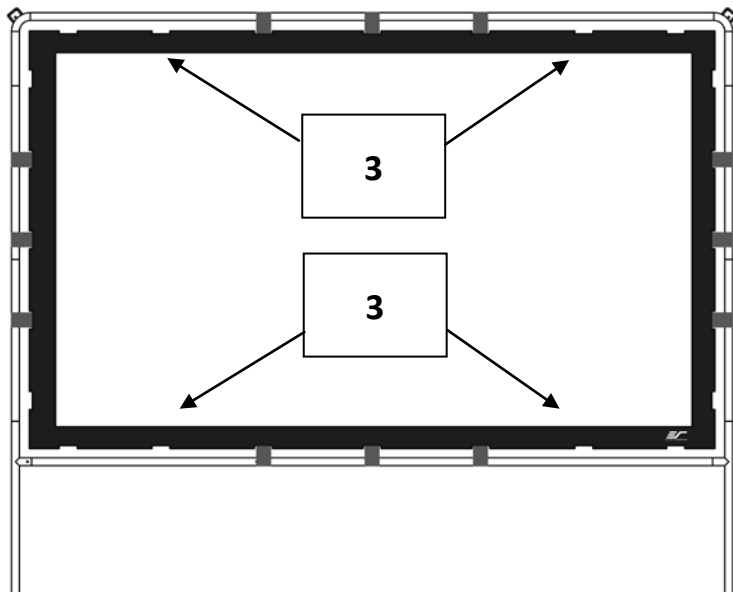

3. Leaving the corner sections for last, attach the remainder of the top and bottom material with the *velcro bands*, using one person on each side to maintain even tensioning and a centered screen. .

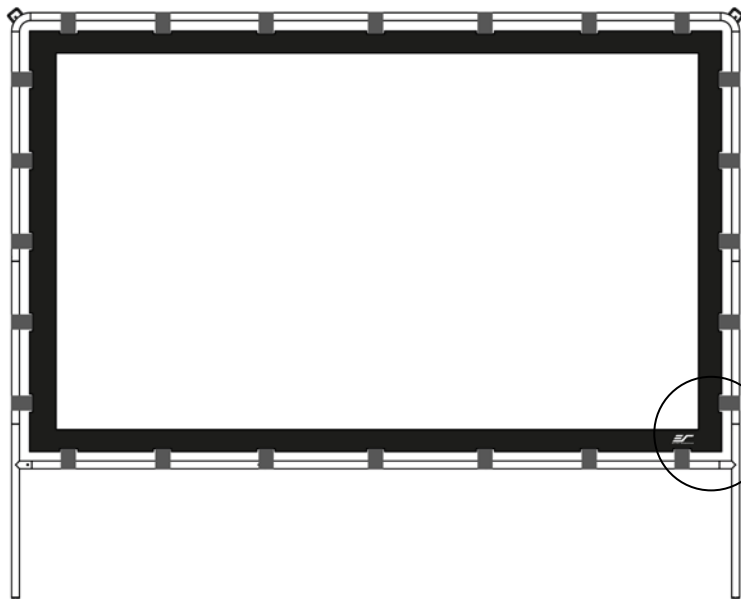

4. Lastly, tightly attach the corner sections of the material with the *velcro bands*. Your screen should look like the figure shown (to the left).

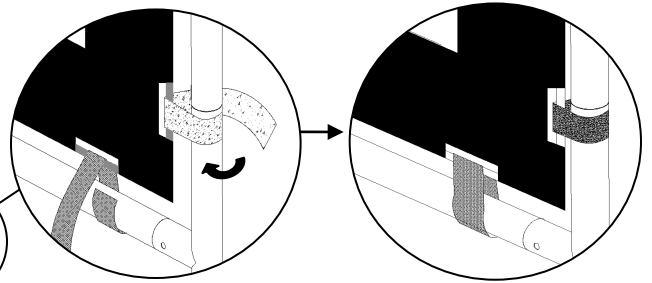

Note:

After all velcro bands are attached, check each individual band for equal tension. If needed, tighten the bands until desired tensioning is achieved.

#### **Step 4: Final Assembly and Main Frame Support set up**

1. Stand the frame upright, and rotate the legs (A) and (J) 90 degrees and insert the hexagonal screws. Secure using the M6 hex nut (I) place.

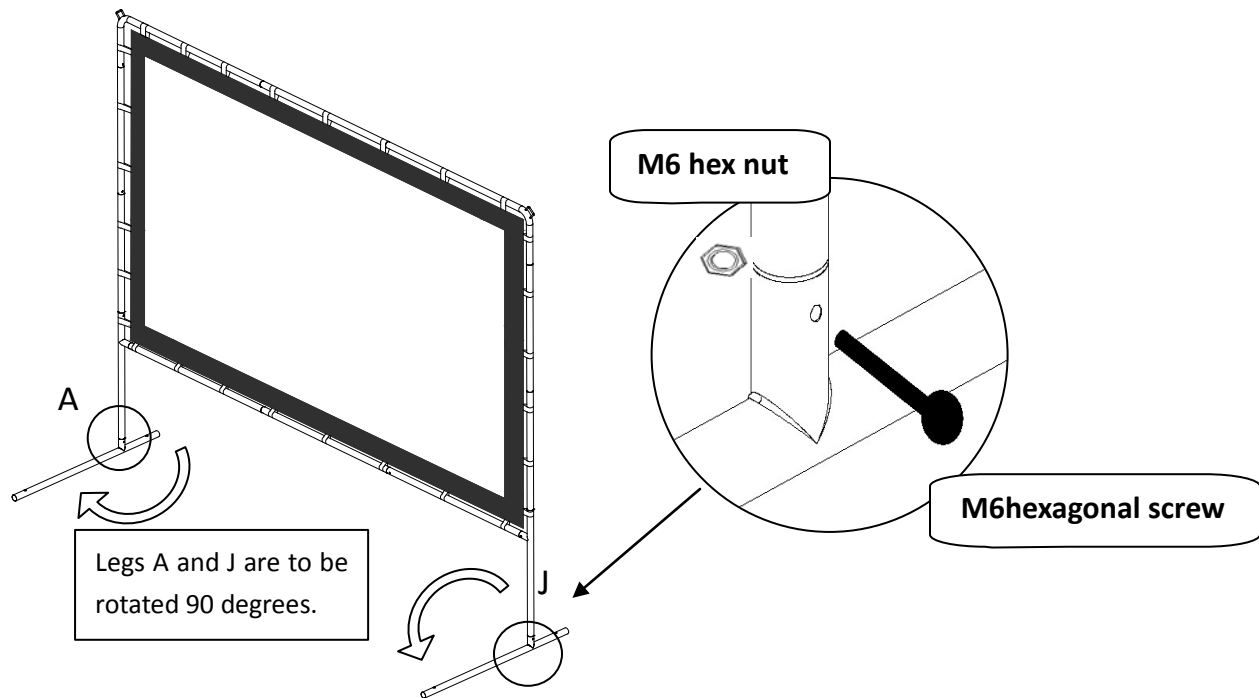

2. Ensure the ring-stakes and guy rope are properly used to safely secure the screen to the ground during use.
3. Drive the Curved Stakes (G) through each hole on the ends of the legs.
4. Drive the Ring-Stakes (H) to the ground and attach a Guy-Rope on each side for additional support and stability.

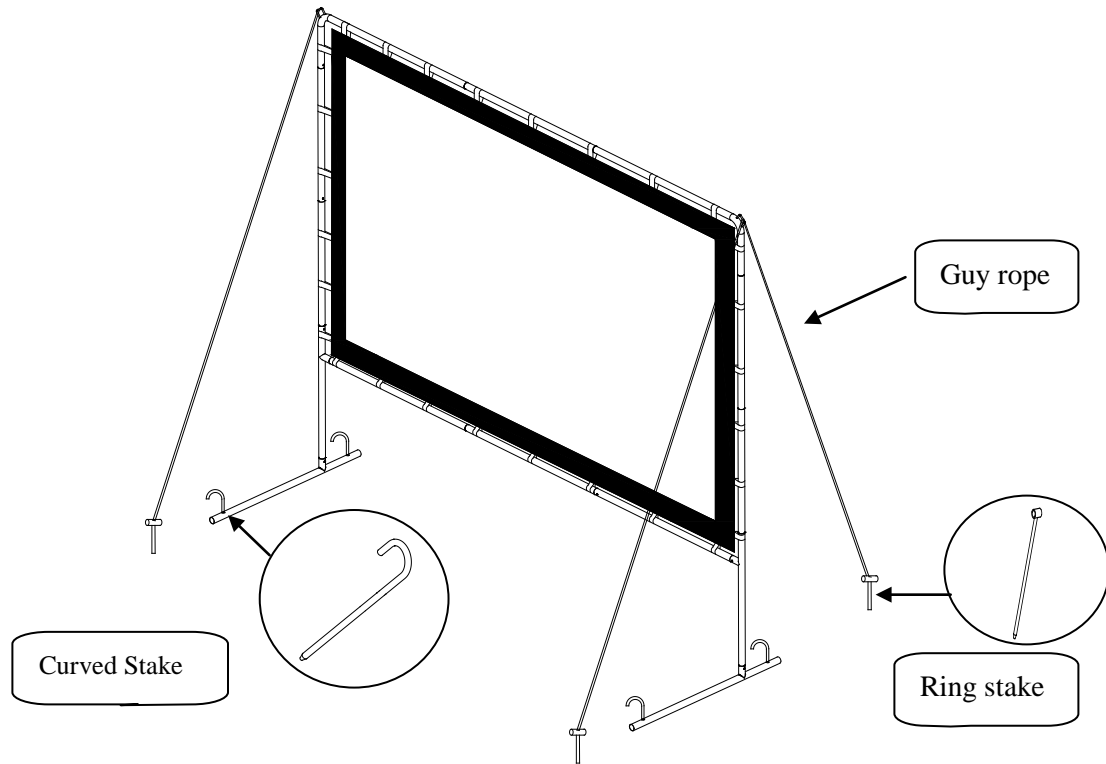

### **Warning Instructions**

1. The Ring-Stake and Curved Stake should be properly driven into the ground to avoid the frame from falling which could result in injury or permanent damage to the screen.
2. Always be cautious of strong windy conditions. We don't recommend using over 20mph.
3. A soft terry cloth with mild soap and water may be used to clean the screen surface.

For a local Elite Screens contact or Technical Support, please visit

[www.elitescreens.com](http://www.elitescreens.com)