

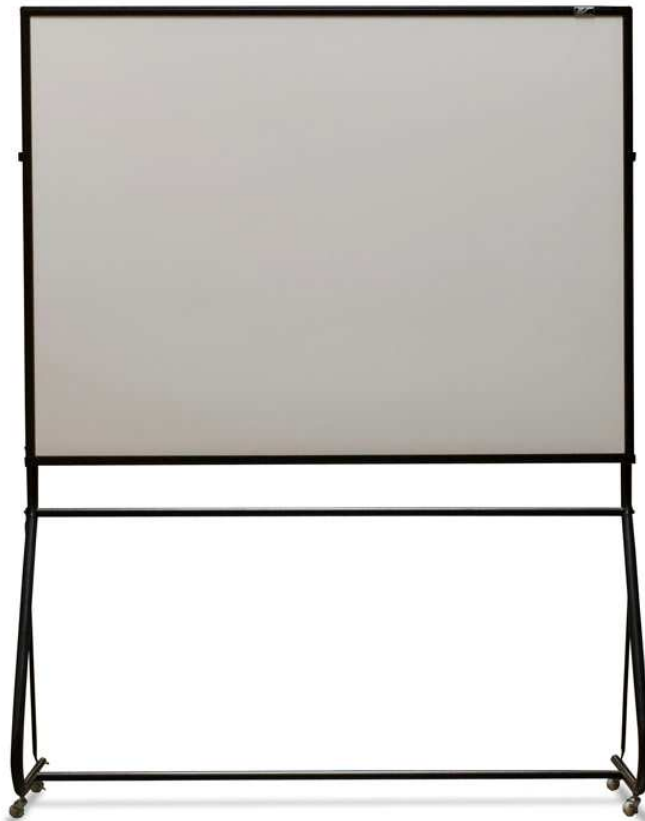

WhiteBoard Projection Screen
Portable Mobile Stand

User's Guide



Parts List for Portable Mobile Stand

Please make sure all parts listed below are included before proceeding with the installation.

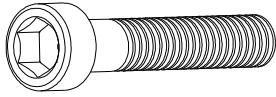

A. M6x40 Hex Screw (12pcs)

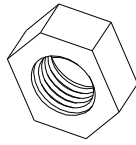

B. M6 Nut (6pcs)

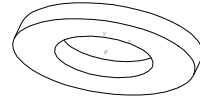

C. M6 Washer (18pcs)

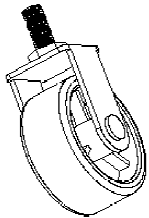

D. Wheel (4pcs)



E1. Top Left Bracket (1pc)

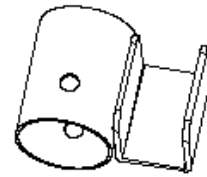

E2. Top Right Bracket (1pcs)

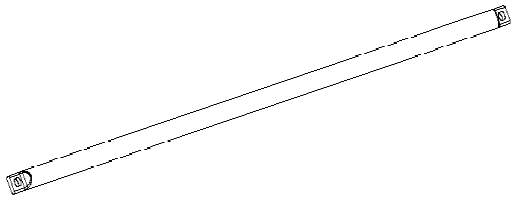

F. Bottom Foot Support Bar (2pcs)

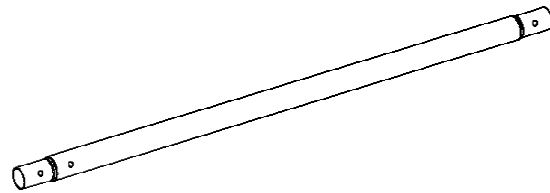

G. Side Legs (2pcs)

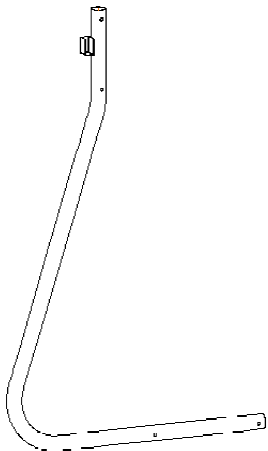

H1. Left Bottom Foot (1pc)

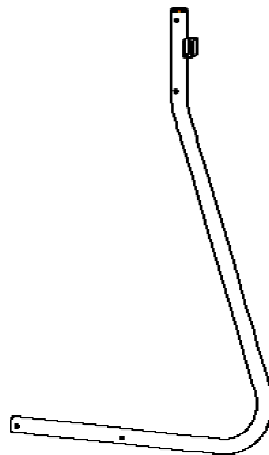

H2. Right Bottom Foot (1pc)

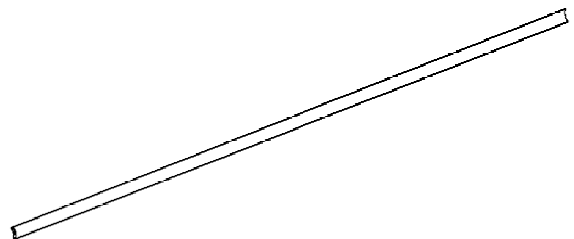

I. Middle Support Bar (3pcs)

Installation Instructions

Elite Screens recommends two persons to assemble the Portable Mobile Stand and to attach the Whiteboard.

1. Insert the Wheels (D) to the Bottom Feet (H1 & H2) as shown in the figure below.

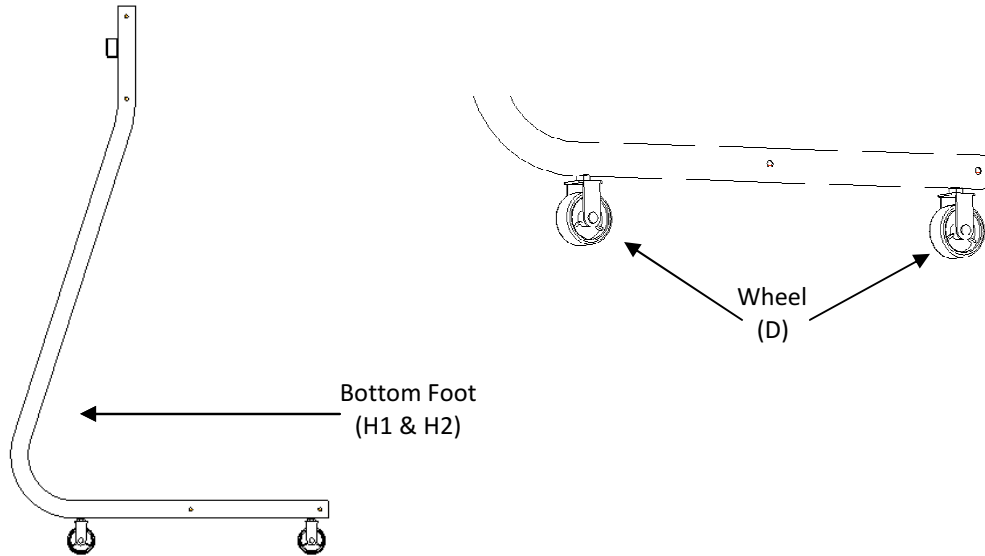

2. Attach one Middle Support Bar (I) to the Bottom Feet (H1 & H2) and secure with the M6x40 Hex Screws (A) & M6 Washers (C).

Note: The three Middle Support Bars (I. x 3pcs) are all the same length.

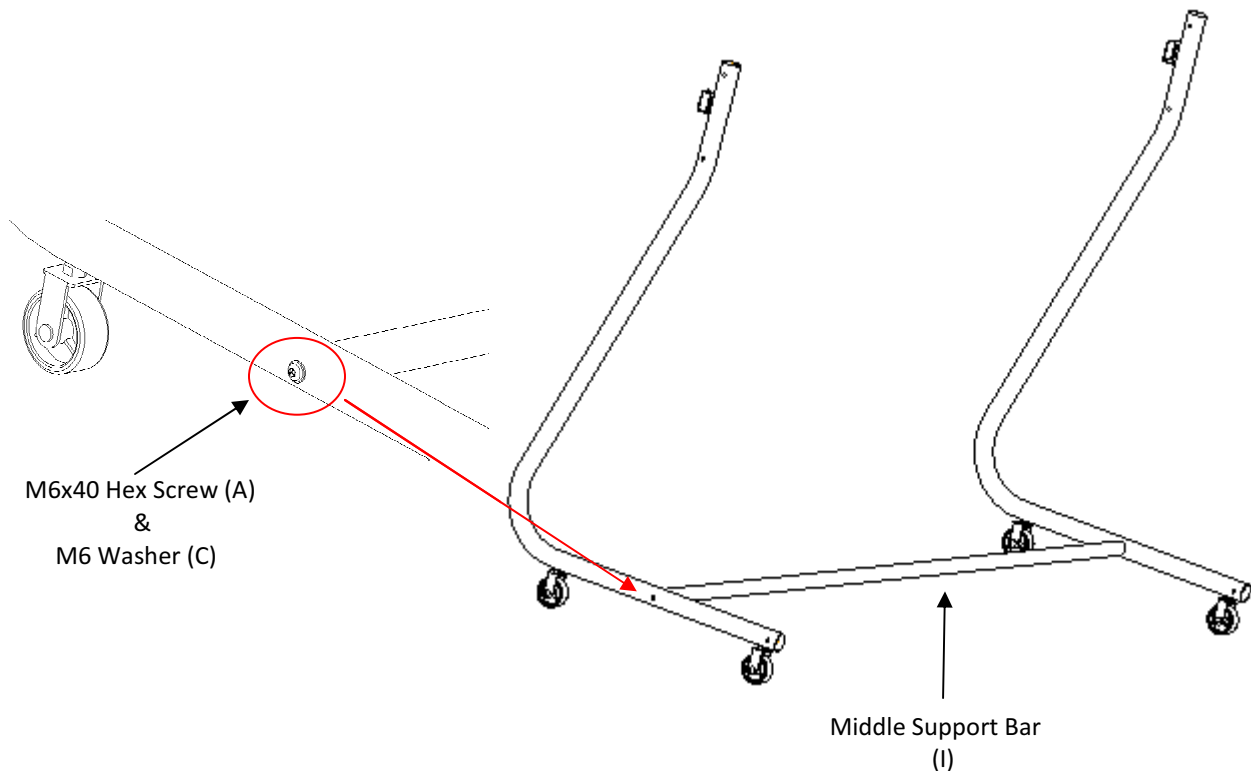

3. Attach the Bottom Foot Support Bars (F) to the Bottom Feet (H1 & H2) and secure with the M6x40 Hex Screws (A), M6 Washers (C) and M6 Nuts (B).

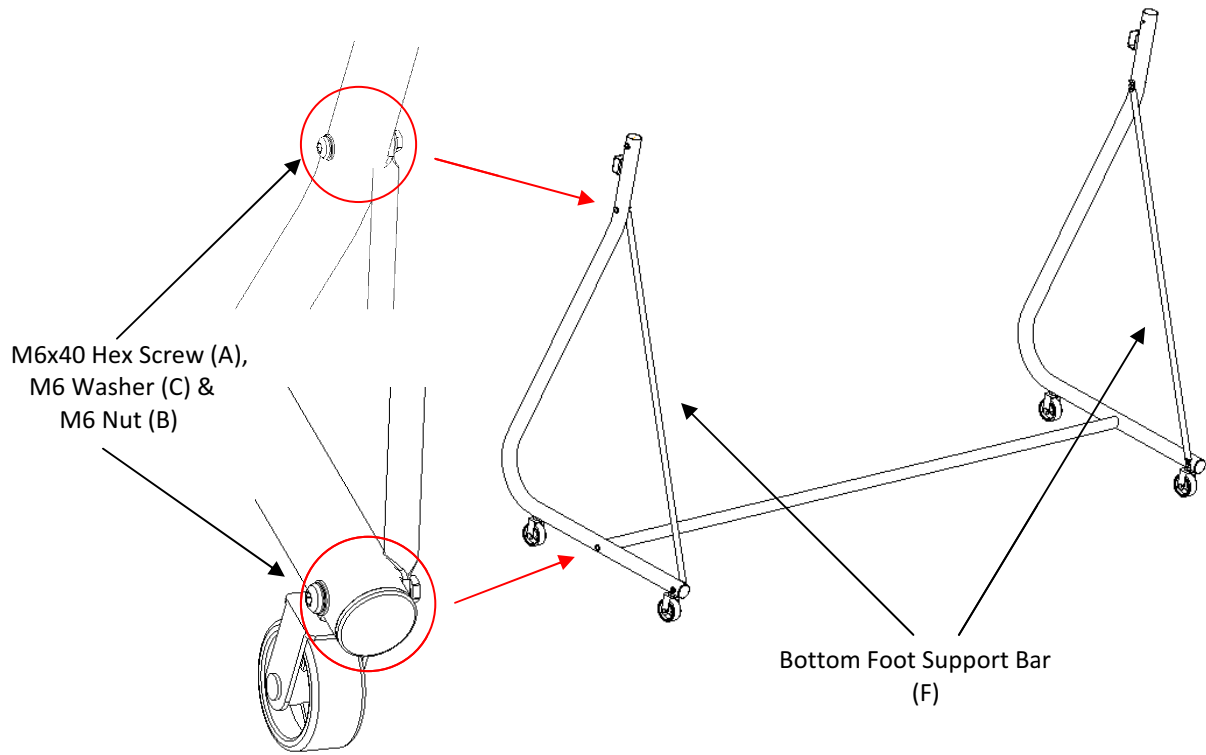

4. Attach the Side Legs (G) to the Bottom Feet (H1 & H2). Attach one Middle Support Bar (I) to the Side Legs (I) and secure with M6x40 Hex Screws (A) & M6 Washers (C).

Note: You will be attaching the 2nd Middle Support Bar (I. x 3pcs).

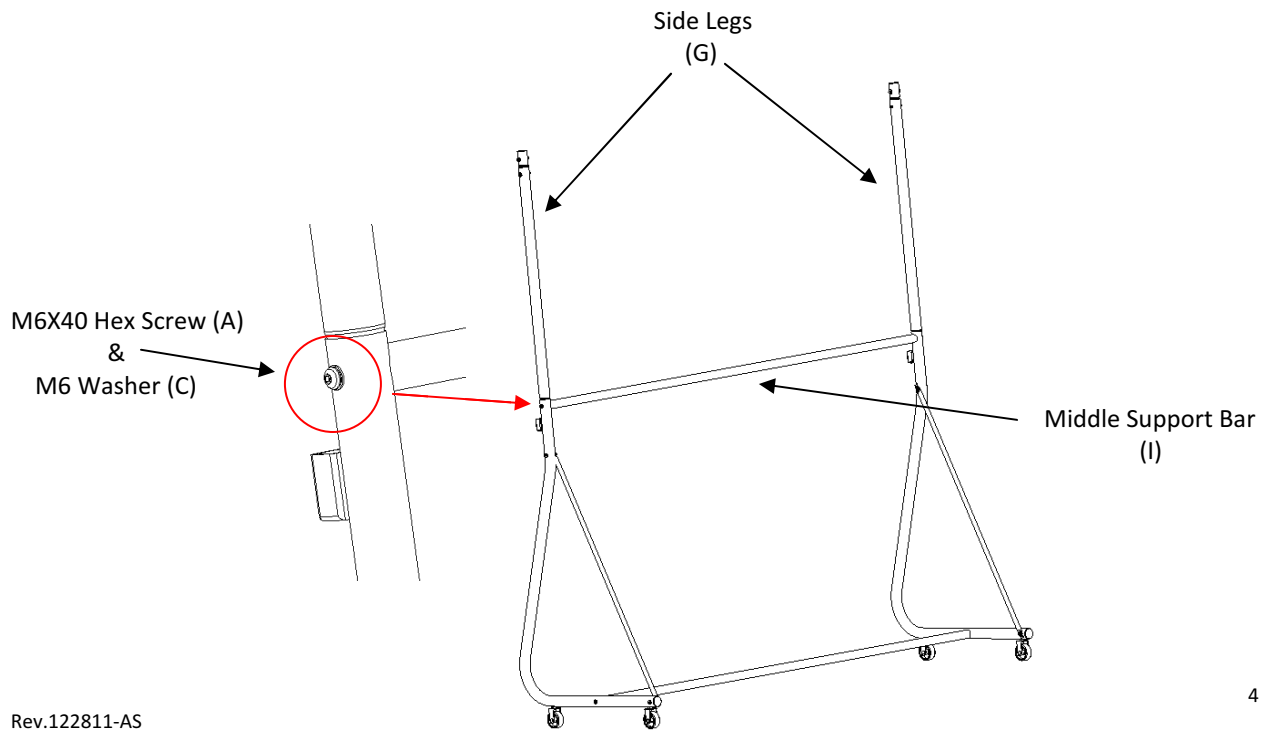

5. Attach the 3rd Middle Support Bar (I) to the Side Legs (G) and secure with M6x40 Hex Screws (A) & M6 Washers (C).

Note: You will be attaching the 3rd Middle Support Bar (I. x 3pcs).

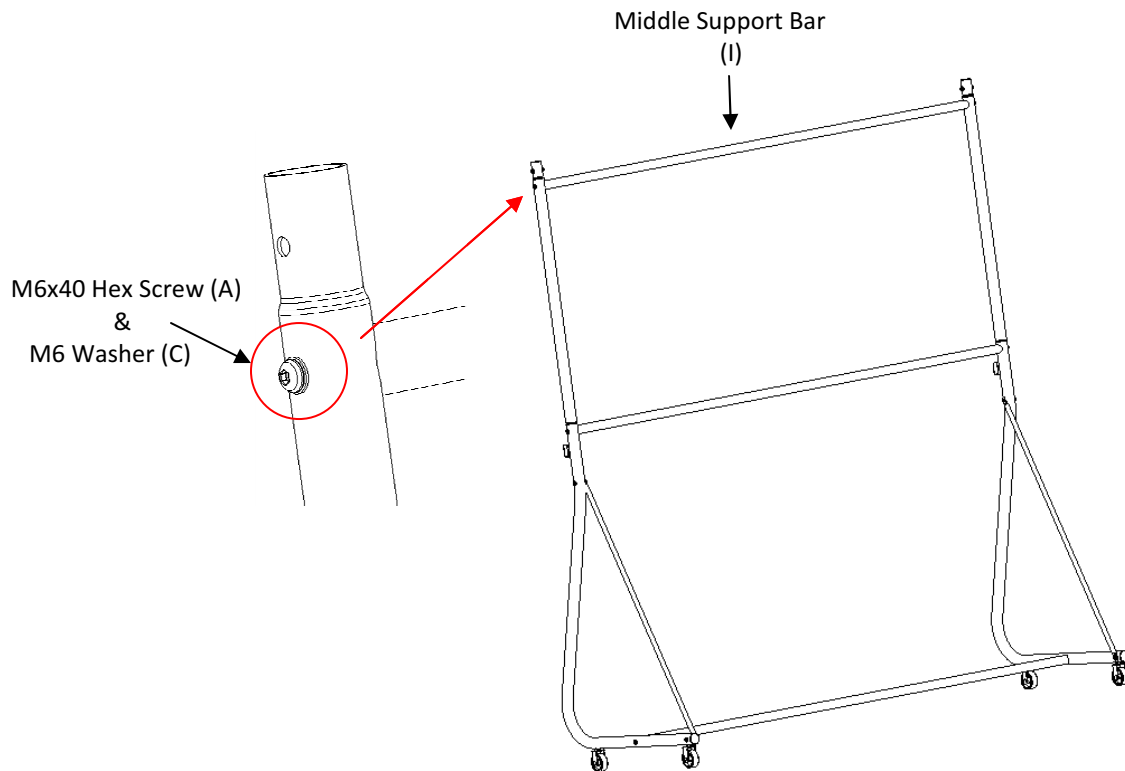

6. Attach the Top Brackets (E1 & E2) to the Side Legs (G) and secure with the M6x40 Hex Screws (A), M6 Washers (C) and M6 Nuts (B).

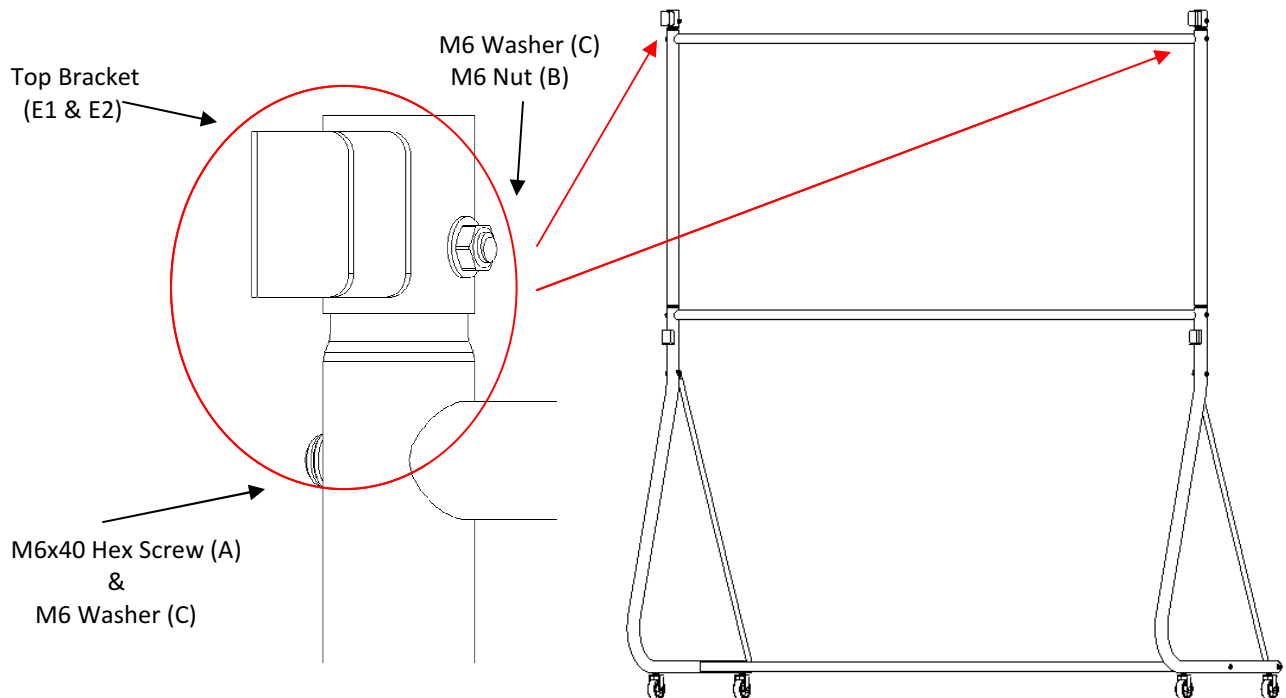

Portable Mobile Stand Dimension Table

| Unit: mm | | | | | | | | | | |
|--------------|-----------------------------|------|------|------|------|------|------|------|------|------|
| Model Number | Screen Diag. & Aspect Ratio | (A) | (A1) | (B) | (B1) | (B2) | (B3) | (C) | (C1) | (C2) |
| ZWBMS-58 | 58" (4:3) | 1221 | 1225 | 1810 | 710 | 970 | 70 | 625 | 960 | 865 |
| ZWBMS-77 | 77" (4:3) | 1611 | 1615 | 1810 | 710 | 970 | 70 | 625 | 960 | 865 |
| ZWBMS-87 | 87" (16:10) | 1920 | 1924 | 1810 | 710 | 970 | 70 | 625 | 960 | 865 |
| ZWBMS-94 | 94" (16:9) | 2125 | 2129 | 1810 | 710 | 970 | 70 | 625 | 960 | 865 |
| Unit: inch | | | | | | | | | | |
| Model Number | Screen Diag. & Aspect Ratio | (A) | (A1) | (B) | (B1) | (B2) | (B3) | (C) | (C1) | (C2) |
| ZWBMS-58 | 58" (4:3) | 48.1 | 48.2 | 71.3 | 28 | 38.2 | 2.8 | 24.6 | 37.8 | 34.1 |
| ZWBMS-77 | 77" (4:3) | 63.4 | 63.6 | 71.3 | 28 | 38.2 | 2.8 | 24.6 | 37.8 | 34.1 |
| ZWBMS-87 | 87" (16:10) | 75.6 | 75.7 | 71.3 | 28 | 38.2 | 2.8 | 24.6 | 37.8 | 34.1 |
| ZWBMS-94 | 94" (16:9) | 83.7 | 83.8 | 71.3 | 28 | 38.2 | 2.8 | 24.6 | 37.8 | 34.1 |

