



Electric Motorized Projection Screen
CineTension Plus Series
User's Guide

Important Safety & Warning Precautions

Make sure to read this user's guide and follow the procedure below.

Caution: The screen's Black Top Drop is already set to its maximum drop distance. There is NO extra Black Top Drop in the roller. Please be aware of this as it will void your warranty with EliteProAV. Unapproved changes or modifications (except for cutting the power cord for hardwire installations) to this unit are prohibited and will void your warranty. For more information, please contact our Technical Support Department at (877) 511-1211 Ext. 604.

- Please retain this user's guide for future reference.
- To avoid damaging the unit, do not use with any unauthorized accessories not recommended by the manufacturer.
- Handle the unit carefully during transportation to avoid any damages.
- To ensure safe and reliable operation, direct connection to a properly grounded power source is advised.
- The power outlet supplying power to the unit should be close to the unit and easily accessible.
- Do not install the unit on uneven or inclined surfaces.
- Do not put heavy objects on the power cord and position it properly to avoid creating a trip obstacle.
- Never overload the power cord to prevent an electric shock or fire due to a loose contact or a short circuit.
- There are not user serviceable parts in this unit. Do not attempt to disassemble this unit by yourself. No one except authorized technicians can open and make repairs to this unit.
- Make sure the power source this unit is connected to has a continuous power flow.
- If there is need to use an extension cord, make sure the cord has an equal rating as the appliance to avoid overheating.
- Do not handle the power plug when your hands are wet or your feet are in contact with water.

Do not use this unit under the following circumstances.

- Disconnect the power cord under the conditions of heavy rain, wind, thunder or lightning.
- Avoid direct Sunshine, rain shower and moisture.
- Keep away from fire sources and high temperature to prevent this device from overheating.

- Cut off the power supply first before transportation or maintenance.
- Fully disconnect from the power supply when the unit is not in use for a long period of time, as should be done with any other electric household appliance.
- To avoid possible injury and/or an electric shock, do not attempt to use the screen if there is obvious damage or if there are any evident broken parts.

Installation Warning

Due to various installation environments, the instructions provided in this user's guide are for reference only. Please consult a professional installation company for further installation and safety advice. The installer must insure that proper mounting hardware is used to provide adequate strength suitable for the installation. EliteProAV is not liable for any faulty installations.

The Screen's **Top Black Drop** is already set to its maximum drop distance. There is **NO** extra top black drop in the roller. Please be aware of this as it will void the limitation of your warranty.

Individual modifications to this product are prohibited and will void the warranty with the manufacturer. Please contact EliteProAV Customer Service for any questions.

NOTE:

This equipment has been tested and found to comply with the limits for a Class B digital device, pursuant to Part 15 of the FCC Rules.

These limits are designed to provide reasonable protection against harmful interference in a residential installation. This equipment generates and can radiate radio frequency energy and, if not installed and used in accordance with the instructions, may cause harmful interference to radio communications.

However, there is no guarantee that the interference will not occur on a particular installation. If this equipment causes harmful interference to radio or television reception, which can be determined by turning the equipment off and on, the user is encouraged to try to correct the interference by one or more of the following measures.

- ✓ **Reorient or relocate the receiving antenna of the device which may be causing the interference.**
- ✓ **Increase the separation between the screen and the device's receiver.**
- ✓ **Connect the equipment into a different power outlet other than the device**

Pre-Installation

1. Carefully unpack the screen.
2. Always handle the screen in a leveled position on a clean surface.
3. In order to protect the screen from exposure to stains, keep the screen out of contact with foreign particles such as dust, sawdust, and/or liquids.

NOTE:

Regardless of the mounting method, the screen should be securely supported so that the vibration or pulling on the viewing surface will not cause the casing to become loose or fall. The installer must insure that the fasteners used are of adequate strength and suitable for the installation location.

Accessories for CineTension Plus Series

Please make sure all accessories below are included before proceeding.

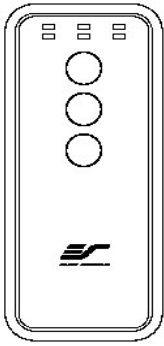

A.
Infrared Remote

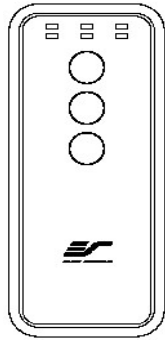

B.
Radio Frequency



Red+
C.
12 Volt Trigger

Green-



D.
3 Way Wall Switch



E.
Infrared Eye Receiver

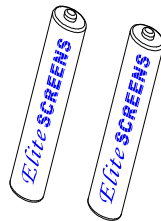

F.
AAA Batteries

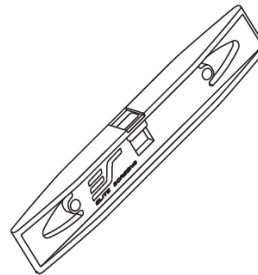

G.
Bubble Level

Installation Instructions

Please consult a professional installer. EliteProAV is not liable for any faulty installations.

1. Select the installation location for your screen. Ensure that it is within reasonable proximity from your power source.
2. EliteProAV provides a built-in suspended ceiling mount bracket for the CineTension Plus. The professional installer would need to provide any hardware and the safest way to install this screen.
 - a. Built in installation bracket.
 - b. Built-in 5-12 volt trigger port (RJ-45) for 12 Volt Trigger, 3 Way Wall Switch and IR Eye Receiver.

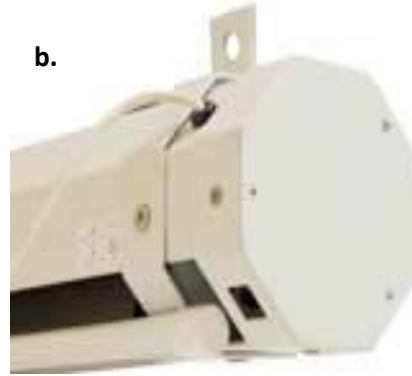
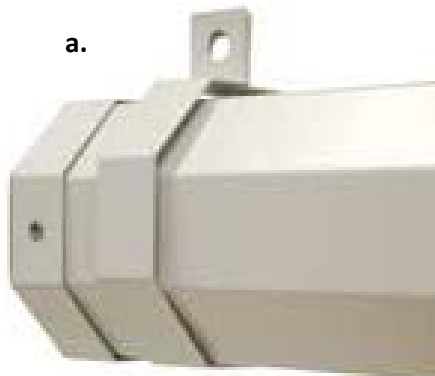

Troubleshooting

For additional information, please contact EliteProAV at techsupport@elitescreens.com

1. If your screen does not move, please check the power supply. The screen will understandably not move without power.
2. Make sure the power cord is firmly plugged to the power outlet.
3. Make sure that all cable connections are secure.
4. If the screen works well with the line switch but not with the remote control, please make sure the remote controls have fresh batteries. Change the batteries every 6 months to ensure proper operation of the remotes.

Dimensions Table

Model Number	A	A3	A1	A2	B	B1	B2	B3	B4	B5	C1	C	D1	E	E1	D
Unit: Inches																
TE180XWH	187.4	180.9	156.9	172.6	108.0	88.3	100.6	2.4	105.6	10.0	5.0	0.6	5.0	7.4	5.4	98.4
Unit: mm																
TE180XWH	4760	4595	3985	4385	2744	2242	2556	60	2683	254	127	15	127	188	138	2500

Note: Data Error: ±1"

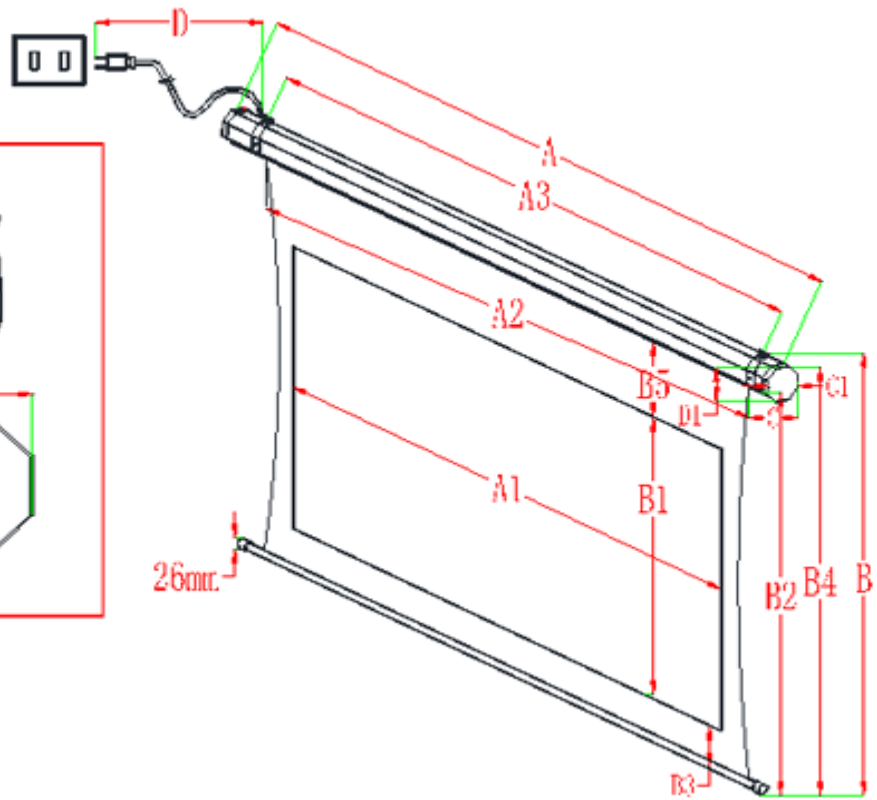
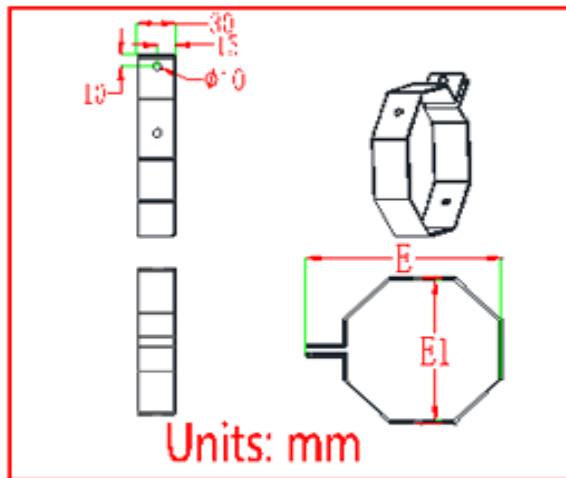

For local EliteProAV contact or Technical Support, please visit www.eliteproav.com